

# CONSTRUCT AND EQUIP THREE TELECOMMUNICATIONS TOWER SITES

for the

## ONEIDA NATION

Publication Date: November 6, 2023



**Proposal due date: Friday, December 15, 2023 at 3 PM, Central Daylight Time**

A non-mandatory pre-bid project briefing is scheduled for Monday, November 13 at 11:00 AM, Central Daylight Time. The meeting will be held online via Microsoft Teams at: [Oneida Prebid meeting](#), short overview of the project will be provided, followed by an opportunity for voluntary questions and discussions. All substantive information that arises will also be published as an official addendum.

# Table Of Contents

INVITATION FOR BID.....Page 2

INSTRUCTIONS TO BIDDERS.....Page 3

BID RESPONSE FORM.....Page 5

CONSTRUCTION BID DOCUMENT.....Page 7

ATTACHEMENTS.....Page 12

    Attachment A: Standard Construction Agreement.....Page 13

    Exhibits.....Page 14

    Attachment B: Specifications.....Page 25

    Attachment C: Site Locations, Site Plans and Descriptions.....Page 54

    Attachment D: Indian Preference Law & Vendors.....Page 66

    Attachment E: Permit Fee Schedule.....Page 97

# INVITATION FOR BID

**Bid Opening Date: Friday, December 15, 2023**

**Bid Opening Time: 3 PM CDT**

## **Construct and Equip Three Telecommunication Tower Sites**

Contractors:

Enclosed is your copy of the bid invitation to **Construct and Equip Three Telecommunications Tower Sites** for the ONEIDA NATION. Your bids are due by **3 PM Central Daylight Time, Friday, December 15<sup>th</sup>, 2023 ???**. No late bids will be accepted, so please make sure to mail your bids early.

The bid packet contains the **Bid Instructions, Bid Response Form, Construction Bid Document, Attachments (A) Standard Construction Agreement, Attachment (B) Specifications, Attachment (C) Site Locations, Site Plans and Descriptions, Attachment (D) Indian Preference Law & Vendors, Attachment (E), Permit Fee Schedule**. Please review all material provided. Each section of information should be considered when determining your bid.

This bid invitation and three geotechnical surveys are posted at the following web address: [Oneida Tower Project \(https://oneida-nsn.gov/business/dts/broadband-home/tower-procurement-information/\)](https://oneida-nsn.gov/business/dts/broadband-home/tower-procurement-information/). Any addendums will also be posted on this site; it is the responsibility of the bidder to **check the website regularly** for updates and once again prior to the submission of your bid.

This project is subject to Indian Preference, Drug Free Workplace Act, and all other applicable federal regulations.

A Bid Bond in the amount of 5% of the bid will be required with your Bid Response Form.

**A notice to proceed to the successful bidder will not be issued until all environmental approvals are secured by ONEIDA NATION.**

A non-mandatory pre-bid project briefing is scheduled for Monday, November 13, 2023 at 11:00 am, Central Daylight Time. The meeting will be held online via Microsoft Teams at: [Click here to join the meeting](#). A short overview of the project will be provided, followed by an opportunity for voluntary questions and discussions. All substantive information that arises will also be published as an official addendum.

All questions procedural or technical must be submitted in written form to the Single Point of Contact (SPOC) Nate Villarreal at [nvillarr@oneidanation.org](mailto:nvillarr@oneidanation.org)

Sincerely,

Jason Doxtator  
Chief Information Officer  
Oneida Nation

# INSTRUCTIONS TO BIDDERS

## GENERAL INSTRUCTIONS

### A. Bid Procedure

#### (1) Bid Submission

Sealed bids will be received by Nate Villarreal, Senior Network Analyst at the Oneida Skenandoah Complex, 909 Packerland Drive, Green Bay, WI. 54303 until 3 PM Prevailing Local Time, on Friday, December 15, 2023 for the purpose of: Furnishing and Installing Three Telecommunications Towers  
Your bid submission should include (2) complete copies and one electronic copy. If sent by US Mail, the mailing address is PO Box 365, Oneida, WI 54155

**Bids received after the date and time stated above will not be considered.**

#### (2) Bid Response Procedures

The response must be made on the provided “*Bid Response Form*”. The signature of the bidder supporting the bid must appear in the space provided on page four (4) of the “*Invitation for Bid*” and the completed bid must be submitted in its entirety. Any deviations from these conditions may be considered sufficient justification to reject the bid.

Bid forms must be filled out in ink or other permanent means. All erasures and corrections must be initialed in ink. Bids must be properly signed by an authorized representative.

Show the following on the bid envelope: (1) Bid Title and publication date, (2) Bid due date and (3) Name and address of bidder.

**Telephone and Facsimile bids will not be accepted.**

#### (3) Pre-Bid Conference

A non-mandatory pre-bid project briefing is scheduled for Monday, November 13, 2023 at 11 AM, Central Daylight Time. The meeting will be held online via Microsoft Teams at [Click here to join the meeting](#). A short overview of the project will be provided, followed by an opportunity for voluntary questions and discussions. All substantive information that arises will also be published as an official addendum.

#### (4) Clarification of Specifications

Any clarifications to the specifications should be submitted in writing to the SPOC at [nvillarr@oneidanation.org](mailto:nvillarr@oneidanation.org) no later than: Monday, November 27, 2023.

It shall be the sole responsibility of the bidder to understand all of the provisions of the bid invitation and contract specifications.

#### (5) Clarification of Bid Responses

The Chief Information Officer reserves the right to obtain clarification of any point in the firm's bid or to obtain additional information necessary to properly evaluate a particular bid. Failure of a bidder to respond to such a request for additional information or clarifications may result in rejection of that firm's bid.

**(6) Alteration of Bids**

Bids may not be completed, amended or clarified on the face of the bid after the official bid opening.

**(7) Time Bid Valid**

All bids must be firm for 180 calendar days from the closing date of the bid.

**(8) Bid Award**

The contract will be awarded to the lowest **Responsible and Responsive bidder.**

**(10) Indian Preference Law Requirements**

Bidder must comply with the Oneida Nation Indian Preference Law described in Attachment D.

A bidder's responsiveness and responsibility will be determined with considerations to Indian Preference requirement compliance.

Noncompliance with the Indian Preference requirement in the resulting contract may result in contract termination for default and debarment and suspension from future contracts.

**THE RIGHT IS EXPRESSLY RESERVED TO REJECT ANY AND ALL BIDS.**

The undersigned proposes to furnish the services or goods herein mentioned at the price indicated, all in accordance with the specifications and provisions as herein set forth, attached hereto and made a part hereof.

The undersigned bidder hereby represents as follows:

That this bid is made without connection with any person, firm or corporation making a bid for the same goods or services, and is in all respects fair and without collusion or fraud.

\_\_\_\_\_  
(Legal Name of Firm or Corporation)

Address: \_\_\_\_\_

\_\_\_\_\_

By: \_\_\_\_\_  
(Signature of Authorized Bidder)

Title: \_\_\_\_\_

Date: \_\_\_\_\_

# **BID RESPONSE FORM**

## **CONSTRUCT AND EQUIP THREE TELECOMMUNICATIONS TOWER SITES**

**BID OPENING: 3:00 pm, CDT, on Friday, December 15, 2023**

Construct and Equip Three Telecommunications Tower Sites as described in Attachment B Specifications and Attachment C Site Locations, Site Plans & Descriptions. Please itemize the costs below, with a separate line for labor and materials as follows:

<b>100 foot Communications Tower (A)</b>		
<b>“Public Safety Tower” County Rd. E</b>	Labor	\$
	Materials	\$
<b>Radio Shelter</b>		
	Labor	\$
	Materials	\$
<b>Generator Set</b>		
	Labor	\$
	Materials	\$
<b>Site Development</b>		
	Labor	\$
	Materials	\$
<b>Road Improvements</b>		
	Labor	\$
	Materials	\$
<b>180 foot Communications Tower (B)</b>		
<b>“NW Tower” N7890 Cooper Rd</b>	Labor	\$
	Materials	\$
<b>Radio Shelter</b>		
	Labor	\$
	Materials	\$
<b>Generator Set</b>		
	Labor	\$
	Materials	\$
<b>Site Development</b>		
	Labor	\$
	Materials	\$

<b>150 foot Monopole Tower (C)</b>		
"Skenandoah Tower" 909 Packer Land Dr.	Labor	\$
	Materials	\$
<b>Radio Shelter</b>		
	Labor	\$
	Materials	\$
<b>Generator Set</b>		
	Labor	\$
	Materials	\$
<b>Site Development</b>		
	Labor	\$
	Materials	\$

**TOTAL BID     \$ \_\_\_\_\_**

**LIST:**

**Tower Manufacturer:** \_\_\_\_\_ **STANDARED WARRANTY PERIOD:** \_\_\_\_\_  
**Shelter Manufacturer:** \_\_\_\_\_ **STANDARED WARRANTY PERIOD:** \_\_\_\_\_  
**Generator Manufacturer:** \_\_\_\_\_ **STANDARED WARRANTY PERIOD:** \_\_\_\_\_

**Company Name:** \_\_\_\_\_

**By:** \_\_\_\_\_

**Address:** \_\_\_\_\_

**Title:** \_\_\_\_\_

\_\_\_\_\_

**Date:** \_\_\_\_\_

# **CONSTRUCTION BID DOCUMENT**

## **Construct and Equip Three Telecommunications Tower Sites**

### **BACKGROUND AND OVERVIEW**

This project is being undertaken by the Oneida Nation. The Oneida Nation is a federally recognized Indian Nation and one of the original members of the Iroquois confederacy. The Oneida Tribe has maintained a homeland in the Northeastern corner of the state of Wisconsin since their 1820's migration. The Oneida reservation was established by treaty in 1838, it includes land located in two Northeastern Wisconsin counties, Brown and Outagamie, and covers an area of more than 65,000 acres, much of which has been checkerboarded through an allotment in the 1920's. The current makeup of the reservation includes more than 30,000 Tribally controlled acres of land.

The purpose of this project is the procurement and development of three new telecommunications towers and related facilities within the Oneida Nation reservation. (see Attachment C: Site Locations, Site Plans and Descriptions). Two lattice towers will be constructed, at 180 feet and 100 feet respectively as well as a monopole tower of 150 feet. The towers and related facilities will be constructed to a public safety grade, meaning that they are designed to remain fully functional in all-hazards environment, during and immediately following all emergency response operations. Further, the lattice towers will be designed to accommodate colocation by other telecommunications providers and must also be considered carrier/commercial grade. Respondents to this bid request are welcome to offer optional items to ensure that these objectives are met.

In addition to the acquisition and installation of the towers, the successful bidder is responsible for the procurement and installation of radio shelters, tower foundations, grounding systems, emergency power, security fencing, weed barrier fabric/rocking/landscaping and overall site development at the three locations listed in Attachment C.

## **PROJECT REQUIREMENTS**

1. Credentials.
  - a. Must have direct experience constructing towers of the type listed below in the specifications.
  - b. Must have certified tower climbers.
2. Intent. It is the intent of the specifications to describe the minimum requirements for the identified tower and equipment.
3. Brand Names. Unless otherwise specifically indicated, articles have been identified in the bid by a "Brand Name" and model number, such reference is intended to be descriptive but not restrictive. It is



for the sole purpose of indicating to the prospective bidders a description of articles that will be satisfactory. Printed literature shall be included with the bid which will confirm that the equipment and/or material being bid fully complies with all of the provisions of this specification.

4. Minimum requirements. The enclosed detailed Specifications shall be construed as **minimum**. Should manufactures' current published data or specifications exceed these, such standards shall be considered minimum and furnished. All parts, items or features not specifically mentioned in the scope of these specifications that are regularly furnished in order to provide a complete working unit shall be furnished.
5. Incidental Costs. Bid price shall include delivery and installation costs and any other costs required to acquire and construct the tower and related facilities.
6. Taxes. Tax exemption for the Oneida Nation:
  - a. Section IV subparagraph F.3.b of the State of Wisconsin Department of Revenue Publication 207 (10/00), titled Sales and Use Tax Information for Contractors ([www.dor.state.wi.us/pubs/00pb207](http://www.dor.state.wi.us/pubs/00pb207)), indicates non-native American contractors may be exempt from Wisconsin State sales tax on certain construction materials delivered to the reservation for use in Tribal projects if Federal Preemption applies. Federal Preemption applies to the Oneida Reservation.
  - b. It is the Contractors responsibility to ascertain the applicability of this State publication to this Tribal project. Contractors who are uncertain as to what items are subject to tax, or who require further explanation or clarification, are requested to contact the Wisconsin Department of Revenue.
7. Warranties. Manufacturers or vendors shall furnish guarantees against faulty workmanship or materials for a minimum period of 12 months from the date of final inspection and shall correct any faulty workmanship or replace, parts and faulty materials during this period at no cost to ONEIDA NATION for labor or other associated costs.
  - a. All materials shall be guaranteed by the Bidder against mechanical, electrical and workmanship defects.
  - b. The warranty period shall commence with the date of acceptance of the tower installation and remain in effect for a minimum of one calendar year, except for routine expendable items.
8. As-Builts. A complete set of as-built drawings shall be provided. (red lined or electronic)
9. Standards.
  - a. Systems must be installed within the guidelines of NEC, (National Electric Code)
  - b. Materials and workmanship shall conform to all codes, regulations and requirements for such equipment, specifications contained herein, and the normal use for which it is intended.
  - c. Materials shall be manufactured in accordance with the best commercial practices and standards for this type of application.
  - d. Materials used in the production of any equipment must be new.

10. Bidder will furnish and install all materials, equipment and/or services necessary to perform contractual requirements of this project in accordance with the manufacture's recommendations and Specifications as listed below.
11. Bidder will adhere to the drawings included in Attachment C.
12. **ALL WORK MUST BE COMPLETED WITHIN THE SPECIFIED TIMEFRAME:**
  - a. **Within 60 days of Notice to Proceed (unless otherwise amended) If bidders require a different construction completion duration, please include this in your bid document**
13. Bidder will be responsible for delivering all materials to the work-site, and any necessary storing.
14. Bidder shall grade the tower sites/compound as necessary.
15. At the option of ONEIDA NATION, Bidder shall perform ground system testing and / or augment the ground system with the addition of chemical ground rods as proposed.
16. Bidder will adhere to all terms and conditions as set forth in the attached sample standard Construction Agreement (Attachment A). Insurance requirements and limits are addressed in document. **Any issues with the standard Construction Agreement must be raised by the bidder prior to bid submission.**
17. Bidder will adhere to the site plan shown in Attachment C.
18. All subcontractors are bound by the same terms and conditions as required by this contract.

1. Division 0 & 1 – General Requirements

- 1.1. All work shall conform to the Oneida Code of Laws, Chapter 603 – Building Code and Chapter 605 - Zoning and Shoreland Protection.
  - 1.1.1. The Oneida Building Code incorporates by reference the State of Wisconsin Commercial Building Codes and the Uniform Dwelling Code.
  - 1.1.2. Codes are available for download on the Oneida Nation website (<https://oneida-nsn.gov/government/register/laws/>).
- 1.2. Contractor shall obtain all required permits from the Oneida Zoning Department.
- 1.3. Contractor shall coordinate all utility disconnects and new utility connections as required. Cost of utility fees shall be included in contract cost.
- 1.4. All Contractors, regardless of tier, are subject to the Oneida Code of Laws, Chapter 502 - Indian Preference in Contracting.

- 1.4.1. Codes are available for download on the Oneida Nation website (<https://oneida-nsn.gov/government/register/laws/>).
- 1.5. The awarded contractor is required to obtain an Oneida Vendor's License, prior to finalizing the contract for the work (if they do not currently hold a vendor's license). The annual fee for the license is due upon application; contact the Oneida Licensing Department at 920-496-5311.
  - 1.5.1. An Oneida Vendor's License is not required for submission of a bid.
- 1.6. Contractor shall provide a Gant chart schedule for the project and keep it current throughout the duration of the project.

## **RESPONSIBILITIES OF ONEIDA NATION**

ONEIDA NATION will provide Bidder reasonable access to the work site, according to ONEIDA NATION' normal notification process.

ONEIDA NATION will provide general inspection oversight of the project; such oversight will not relieve bidder of any of their contractual obligations.

ONEIDA NATION will consider progress payments for delivery of goods or completion of work to the successful bidder based on negotiated payment terms in the contract. Deposits and down payments are not an option.

ONEIDA NATION is providing geotechnical engineering evaluation reports for each of the three tower sites for use as background information for the footing/foundation design of the tower. The reports are available at the following web address: <https://oneida-nsn.gov/business/dts/broadband-home/tower-procurement-information/#GeoTech-Surveys>. Bidder assumes full responsibility for the design and implementation of the tower footings/foundation, irrespective of the information provided in the geotechnical engineering evaluation reports.

# SUMBITTALS

## EXPERIENCE: (to be used in determining responsibility)

The Bidder shall provide evidence of the qualifications for completing the work proposed:

### 1. Qualifications

- a. Bidder must hold all required credentials, licenses and certifications including but not limited to, a CCB Contractor License.

### 2. References

- a. Bidder shall provide references for last three projects completed of similar size and scope, including completion dates and project cost.
- b. Bidder shall provide names and phone numbers of the contact person for each reference.

### 3. Expertise and Staff Experience

- a. Bidder shall identify past projects that are similar in nature.
- b. Bidder shall have a minimum of 10 years of experience on similar projects.

### 4. Required Information

- a. Bidder must provide a work plan with complete description of the proposed work:
  - i. Tower, radio shelter and generator procurement
  - ii. Site development
  - iii. Installation
  - iv. Work schedule
  - v. How Indian Preference requirements will be complied with.
    1. Subcontractors
    2. Laborers
    3. Trainees
  - vi. Bidder must specify the tower manufacturer, model / series and warranty period. Bidder must use one of the 3 approved tower manufacturers: 1. Valmont/Microflect; 2. Sabre; and 3. Rohn.

# ATTACHMENTS

Attachment A: **Standard Construction Agreement**

Attachment B: **Specifications**

Attachment C: **Site Locations, Site Plans and Descriptions**

Attachment D: **Indian Preference Law & Vendors**

Attachment E: **Permit Fee Schedule**

# Attachment A: Standard Construction Agreement

## Construction, Installation, Repair or Remodel Project

This Agreement is entered into by and between the Oneida Nation, whose mailing address is P.O. Box 365, Oneida, Wisconsin, 54155, and

Name:

Address:

Federal ID Number:

Vendor Number:

Project Title:

Project Number (if any):

Agreement Amount:

hereinafter referred to as “Contractor”, who hereby mutually agrees as follows:

**1. Definitions.** All words and phrases contained herein shall have the meaning consistent with the *Architect’s Handbook of Professional Practice* (Ed. 1996), and the *Glossary of Construction Industry Terms*, unless otherwise defined in this Agreement.

**2. Term.** The Term of this Agreement is from **Start Date** to **End Date**, and shall be effective upon the signing of both parties.

**3. Commencement of Work.** No work may be commenced and no materials may be ordered under this Agreement until all parties have signed this Agreement, all appropriate approvals have been obtained, and a Purchase Order has been issued. Upon the issuance of the Purchase Order, the Nation will issue a Notice to Proceed to Contractor. Upon receiving a Notice to Proceed, Contractor may commence work under this Agreement. If Contractor orders any materials or supplies prior to receiving a Notice to Proceed, Contractor agrees that it is responsible for all costs related to said materials and supplies until all conditions of this Section have been satisfied.

**4. Compensation and Payment.** The Oneida Nation shall pay Contractor for the timely and satisfactory performance of the work under this Agreement the sum set forth herein (“Contract Sum”) specified in Exhibit A, which shall be attached hereto and incorporated by reference. Multiple and partial payments shall be provided for in Exhibit A. All amounts payable by the Oneida Nation to Contractor under this Agreement shall be payable within thirty (30) days of the Oneida Nation’s receipt of Contractor’s invoice subject, however, to Contractor’s complete and proper performance and delivery of all services and deliverables that are the subject of the invoice. The Oneida Nation reserves the right to withhold payment based upon reasonable objection which shall be documented.

**5. Scope of Work.**

a. Contractor shall perform all of the work necessary for the construction, installation, and completion of the project, which is described in Exhibit A. Any and all specifications, drawings, and other documents that may be attached hereto are incorporated by reference (collectively “Agreement documents”).

b. Contractor agrees to provide and be responsible for all necessary equipment and tools (collectively “Equipment”) required for the performance of work under this Agreement. If it is determined that Contractor will use Oneida Nation’s Equipment for any reason, such Equipment shall be identified and specified in a separate document attached to this Agreement and incorporated by reference herein. Where Contractor uses Gaming Facilities Lift Equipment, Contractor shall contact the Gaming Facilities Department and complete a Lift Request Form and Lift Equipment/Operator Inspection Check List. Both forms shall be attached hereto and incorporated by reference herein, with a copy to be provided to the Gaming Facilities Department for record keeping purposes.

c. Contractor agrees that only its employees shall use Oneida Nation’s Equipment for any work performed under this Agreement. In Contractor’s use of Oneida Nation’s Equipment, Contractor warrants and represents that any of its employees who use and operate Oneida Nation’s Equipment are properly trained and certified/licensed to use such Equipment. Contractor also warrants and represents that it has sufficient Contractor liability coverage, consistent with the provisions of Section 14, to cover any claims for damages to Gaming Facilities Department Lift Equipment arising from work performed under this Agreement.

d. Where Contractor uses Oneida Nation’s Equipment for the performance of work under this Agreement, then Contractor agrees to indemnify and hold Oneida Nation harmless from and against any and all claims for any injuries to Contractor’s employees or subcontractor’s employees, and any losses or damages to Contractor’s property or subcontractor’s property.

**6. Project Schedule.** Contractor shall perform the work under this Agreement in accordance with a Project Schedule submitted to the Oneida Nation, unless determined otherwise between the parties. Where a Project Schedule is submitted, such Project Schedule shall be attached hereto and incorporated by reference, and shall be reviewed at appropriate intervals as determined between the parties. The Project Schedule may be revised as determined between the parties.

## **7. Changes in the Work.**

a. The Oneida Nation may at any time issue a written Change Order and Contractor may at any time request a written Change Order. Any Change Order shall describe the extent or scope of the work changes covered under this Agreement, changes to any drawings, specifications or other description herein, or to change the time of completion. Such Change Order shall be effective upon signature of both parties and Contractor will promptly comply.

b. Upon receipt of a written Change Order, Contractor shall promptly advise the Oneida Nation if the change will affect its cost of work performed under this Agreement. If Contractor anticipates additional costs as a result of the Change Order, Contractor shall provide to the Oneida Nation: 1) a breakdown of estimated costs and changes in the Agreement Sum; and, 2) a written statement of necessary changes in the time of completion.

## **8. Events of Defaults; Stop Work Orders.**

a. Contractor shall pay costs of work as they are incurred. If Contractor fails to pay any costs as they are incurred, Oneida Nation reserves the right to pay such costs directly, and with written notice to Contractor, shall deduct such costs from the Agreement Sum.

b. If Contractor is deficient in performing work under this Agreement, or any materials do not meet specifications, the Oneida Nation shall notify Contractor in writing to remedy the deficiency within ten (10) business days. If Contractor fails to remedy such deficiency within ten (10) business days, the Oneida Nation shall be entitled to remedy such deficiency and may deduct any cost incurred from the Agreement Sum.

c. If Contractor fails to correct any defective or nonconforming work, or repair or replace any defective materials, or otherwise fails to carry out work as required by the Agreement documents within ten (10) business days as provided in Section 8(b) above, the Oneida Nation reserves the right to issue a written Stop Work Order to Contractor. If a written Stop Work Order is issued, Contractor shall be excused from proceeding with the work so long as such Stop Work Order remains in effect. The Oneida Nation shall notify Contractor in writing when work may be resumed under this Agreement.

d. If Contractor is in substantial and material non-compliance with this Agreement, the Oneida Nation reserves the right to immediately issue a written Stop Work Order to Contractor. Contractor shall be provided reasonable opportunity to come into compliance with this Agreement, at which time the Oneida Nation shall notify Contractor in writing when work may be resumed under this Agreement.

**9. Independent Contractor.** The Contractor warrants and represents that it carries the appropriate workers compensation policy coverage, consistent with the Oneida Nation's Insurance Requirements, and that no persons employed or performing under the terms of this Agreement are excluded under that coverage. Further, the Contractor agrees to and shall indemnify and hold the Oneida Nation harmless against and from any and all loss, damages or costs incurred for any workers compensation claims including, but not limited to, attorneys' fees. The Contractor shall be responsible for all withholding and any other employment taxes due to any taxing authority.

**10. Employees of Contractor.**

a. Contractor agrees that all of its officers, employees, agents, directors, and representatives shall not be deemed or construed to be an employee of the Oneida Nation. Contractor further agrees that it and all of its employees waive any and all rights to the Oneida Nation's benefit plans, including but not limited to 401(k), or life or medical insurance plans. Contractor further agrees that it shall not use, or cause to be used, any of Oneida Nation's employees in the course of any work performed under this Agreement.

b. Contractor shall have a qualified Project Manager on the Project site at all times during the Project while work is being performed. 1The Oneida Nation shall have the right to review the qualifications of Contractor's Project Manager, including by personal interview, and reject the Project Manager at Oneida Nation's discretion. Contractor will not be entitled to additional compensation for replacing Project Manager. 2Contractor shall not change the Project Manager during the course of the Project without the prior written approval of the Oneida Nation.

**11. Materials and Documents; Non-Disclosure.**

a. Unless otherwise specified, all materials shall be new and shall meet specifications. Both materials and workmanship shall be of good quality. Upon reasonable request of the Oneida Nation, Contractor shall provide samples or other satisfactory evidence as to the kind and quality of materials to be used in the performance of the work under this Agreement, and shall be documented in writing. All materials furnished by Contractor shall be in accordance with approved samples. Any substitutions require prior written approval by the Oneida Nation consistent with Section 7 above.

b. All plans and specifications prepared by Contractor shall be submitted to the Oneida Nation for written approval before procurement of materials or commencement of work under this Agreement. Contractor will provide copies of all plans and specifications to the Oneida Nation before commencement of work.

c. Unless provided otherwise, all designs, plans, specifications, improvements, inventions, and rights developed by Contractor in the course of performing work under this Agreement will be disclosed to the Oneida Nation and will become the exclusive property of the Oneida Nation. Contractor hereby assigns all rights, title and interest to the Oneida Nation and ownership shall vest in the Oneida Nation. However, where Contractor possesses intellectual property rights or other proprietary rights in any documents or materials used in the



performance of this Agreement, such intellectual property and proprietary rights shall be described and identified in a separate written document, which shall be attached hereto and incorporated by reference. The Oneida Nation agrees that where Contractor may use documents and/or materials that are licensed by third parties, contractor shall not be caused to violate any existing agreements in place with such third parties.

**d.** Contractor will provide to the Oneida Nation all drawings, specifications, electronic media (CAD files), or other documents, whether tracings or originals, which will remain the property of the Oneida Nation. Contractor will not copy or otherwise reproduce any drawings, specifications or documents, except as required during the performance of this Agreement. Any and all reproductions will be returned to the Oneida Nation upon completion or termination of this Agreement.

**e.** Any information and documents provided to Contractor by the Oneida Nation for purposes of this Agreement shall be treated as confidential and proprietary, and subject to non-disclosure. Any Confidential Information provided to subcontractors shall be on a need to know basis and subject to non-disclosure.

## **12. Use of Premises.**

**a.** The Oneida Nation and Contractor shall agree in writing upon a designated storage area for Contractor's equipment and materials during performance of this Agreement. If designated storage area is contained, Contractor shall provide appropriate signage as to warnings and safety precautions, unless agreed otherwise between the parties. If Contractor will require additional storage area, or a relocation of storage area, on the Oneida Nation's premises, such changes will be made in writing and approved by the Oneida Nation before moving any equipment and materials to such area.

**b.** Contractor will perform all work under this Agreement during the hours designated by the Oneida Nation and in such a manner to reasonably avoid inconvenience to the Oneida Nation and not interfere with business operations. Contractor will properly supervise all work performed under this Agreement, and will require all its employees to comply with all applicable rules and regulations. Contractor will take precautions to protect work, property and persons under a reasonable standard of care. Contractor will perform all work in a professional, safe, and workman like manner, in accordance with applicable industry standards, and with due regard to ethical business practices.

## **13. Indemnification.**

**a.** Contractor shall indemnify and hold harmless the Oneida Nation, its officers, employees, agents, directors, and representatives, in the course of performance of the Contractor's work under this Agreement, from and against any and all claims, of whatever nature, for injuries or losses, or damages arising out of Contractor's or subcontractors negligence, gross negligence, or intentional misconduct, including but not limited to Contractor's breach of this agreement, or the negligence, gross negligence or intentional misconduct of Contractor's or subcontractors officers, employees, agents, directors, and representatives.

**b.** The Oneida Nation shall indemnify and hold harmless Contractor, its officers, employees, agents, directors, and representatives, from and against any and all claims, of whatever nature, for injuries or losses, or damages arising out of the Oneida Nation's negligence, gross negligence, or intentional misconduct, or the negligence, gross negligence or intentional misconduct of the Oneida Nation's officers, employees, agents, directors, and representatives.

## **14. Insurance Requirements.**

**a.** Contractor, at its expense, and as a condition of this Agreement, will obtain and maintain sufficient Contractor liability coverage, consistent with the Oneida Nation's Insurance Requirements, to cover any claims for damages, including personal injury and/or death, which may arise from the performance of work under this Agreement. Contractor shall name the Oneida Nation as Additional Insured prior to any work commencing and shall provide documentation verifying the same for a period of one year following substantial completion.

Contractor shall provide Certificate of Insurance complying with the coverage limits of the Oneida Nation, which shall be filed directly with Oneida Nation's Risk Management Department.

**b.** Certificates of Insurance may be subject to the Oneida Nation's Risk Management Department approval for sufficiency of adequate coverage at any time upon reasonable written notice to Contractor. Contractor will provide the Oneida Nation's Risk Management Department at least thirty (30) days advance written notice in the event of cancellation, termination, or material modification of the coverage. Contractor is responsible for obtaining insurance covering their tools, equipment, and materials which are not destined to be incorporated into the final project.

**c.** Where Contractor fails to be in compliance with any provisions of this Section, the Oneida Nation reserves the right to immediately issue a written Stop Work Order to Contractor consistent with Section 8(d) above. Contractor shall be provided reasonable opportunity to come into compliance with the provisions of this Section, at which time the Oneida Nation shall notify Contractor in writing when work may be resumed under this Agreement. If Contractor is unable to meet the requirements of this Section, the Oneida Nation reserves the right to terminate this contract.

## **15. Licensing, Permits, and Regulatory/Statutory Requirements.**

**a.** Contractor is required to obtain an Oneida Vendor's License from the Oneida Nation's Licensing Department.

**b.** Contractor warrants and represents that its employees and all subcontractors shall comply with all applicable laws, rules and regulations for licensing and training as to trade and industry, and that said employees and subcontractors shall maintain licensing requirements for the Term of this Agreement. The Oneida Nation shall have the right to review the license qualifications of Contractor's employees and subcontractors, and to reject any of Contractor's employees or subcontractors at its discretion for non-compliance.

**c.** If required by applicable laws, rules or regulations, Contractor agrees to obtain all necessary permits from the appropriate licensing authorities and provide all notices required for the performance of this Agreement prior to commencing any work. The Oneida Nation shall have the right to review all permit applications and permits obtained by Contractor for the performance of this Agreement upon request. If Contractor and its employees, or any of its subcontractors, performs any work contrary to applicable laws, rules and regulations, Contractor will be responsible for any costs as a result of non-compliance. If Contractor is unable to obtain the necessary licenses and/or permits required for the performance of this Agreement, the Oneida Nation reserves the right to obtain any necessary licenses and/or permits and deduct those costs from the Sum, and Contractor may proceed with work under this Agreement.

**d.** Where applicable, Contractor shall make arrangements for public and private locates prior to commencing any work, and shall notify the Oneida Nation of completion of locates with appropriate confirmation numbers on a regular and periodic basis until work is completed. Contractor will be responsible for maintaining documentation of appropriate confirmation numbers, and shall provide such documentation upon the Oneida Nation's request.

**e.** Contractor agrees to the provisions of the Oneida Indian Preference Law, agrees that compliance is a condition of this Agreement, and agrees that such provisions shall govern the performance of the Contractor under this Agreement. Where Contractor is an Indian Preference Contractor, as established under Indian Preference guidelines and criteria, any insurance requirements established by the Indian Preference Department shall apply to Indian Preference Contractors performing work under this Agreement. The Indian Preference Department shall have all rights of enforcement as provided under the Oneida Indian Preference Law and subsection (f) below.

**f.** Where Contractor fails to be in compliance with any provisions of this Section, the Oneida Nation reserves the right to immediately issue a written Stop Work Order to Contractor consistent with Section 8(d) above. Contractor shall be provided reasonable opportunity to come into compliance with the provisions of this

Section, at which time the Oneida Nation shall notify Contractor in writing when work may be resumed under this Agreement. If Contractor is unable to meet the requirements of any provisions of this Section, the Oneida Nation reserves the right to terminate this contract.

**16. Waste Management and Recycling.** The Contractor shall employ processes that ensure the generation of as little waste as possible due to error, poor planning, breakage, mishandling, contamination, or other factors. Contractor shall minimize trash/waste disposal in landfills; reuse, salvage, or recycle as much waste as economically feasible. Contractor shall separate, store, protect, and handle at the site recyclable waste products in order to prevent contamination of materials and to maximize recyclability of materials. Contractor shall arrange for timely pickups from the site or deliveries to recycling facility in order to prevent contamination of recyclable materials. Contractor shall comply with applicable regulatory requirements, including but not limited to Federal, State and local requirements, pertaining to legal disposal of all construction and demolition waste materials. The following may not be disposed of in landfills or by incineration and shall be recycled, salvaged, or reused:

- a. Aluminum and plastic containers.
- b. Corrugated cardboard.
- c. Wood pallets.
- d. Clean dimensional wood.
- e. Metals, including packaging banding, metal studs, sheet metal, structural steel, piping, reinforcing bars, door frames, and other items made of steel, iron, galvanized steel, stainless steel, aluminum, copper, zinc, lead, brass and bronze.

**17. Contractor Guarantee.** Contractor guarantees to the Oneida Nation that all work performed under this Agreement shall be free from all defects of any kind, nature or description on the date of completion and for a period of one year thereafter. During the period of one year after completion, Contractor agrees to repair/replace any defective work and/or materials at Contractor's expense. Consistent with the statute of limitations, latent defects shall survive the warranty period and Contractor shall be responsible for cure of such defects.

**18. Subcontracts.**

a. Contractor shall not subcontract any work under this Agreement without the express written consent of the Oneida Nation. If Contractor enters into subcontracts with the Oneida Nation's written consent, Contractor agrees to obtain the contract of any and all subcontractors to be materially and substantially bound by the terms and conditions set forth herein, unless otherwise agreed to by the Oneida Nation in writing. Upon reasonable written request, all subcontractor contracts shall be furnished to the Oneida Nation. This Agreement shall be attached and incorporated into all subcontractor agreements.

b. Contractor is responsible for subcontractor compliance with all insurance requirements set forth in this Agreement. In the event of subcontractor non-compliance, such subcontractor work will not proceed under this Agreement until subcontractor is materially and substantially in compliance with the terms and conditions of this Agreement, unless otherwise agreed to by the Oneida Nation in writing.

**19. Separate Agreements.** The Oneida Nation has the right to execute other agreements in connection with the work performed under this Agreement, upon reasonable notice to Contractor. If other Agreements are executed in connection with the work performed under this Agreement, then the Oneida Nation shall coordinate all work between Contractor and other contractors. Contractor and other contractors shall exercise good faith efforts to perform all work under this Agreement.

**20. Third Party Warranties.** Contractor grants to the Oneida Nation any and all warranties which may exist in favor of Contractor from third party suppliers used by Contractor in performing services under this Agreement, and such warranties shall specify the period of time covered by manufacturer.

**21. Force Majeure.** If Contractor is delayed in the performance of or completion of the work under this Agreement by labor strikes, lock-outs, unavoidable casualties, or other causes beyond the control of the Contractor and without its fault or negligence, then the time for the performance or completion of said work may be extended for a reasonable period by written agreement between the parties.

**22. Dispute Resolution.**

**a.** In the case of any dispute or claim arising out of or relating to this Agreement, or with respect to a breach thereof, the parties first shall seek to resolve such matter amicably through discussions between the parties, then, if necessary, by nonbinding mediation.

**b.** Disputes, claims, or questions arising from the performance of this Agreement shall be submitted in writing by the initiating party to the receiving party. The receiving party shall render a written response with a reasonable period of time. Upon receipt of the written response, the parties' representative shall meet at a mutually agreeable location to negotiate a settlement between them.

**c.** Any dispute, claim or other matter in question between the parties shall be subject to mediation upon the written request of either party. However, no demand for mediation of any such dispute, claim or other matter may be made until the earlier of (1) the date on which the receiving party has rendered a written response, or (2) the 10<sup>th</sup> (tenth) day after the initiating party has presented its documentation to the receiving party or has been given a reasonable opportunity to do so, if the receiving party has not provided a written response by that date.

**d.** The parties recognize that mediation proceedings are settlement negotiations, and that all offers, promises, conduct and statements, whether written or oral, made in the course of the proceedings, are inadmissible in any court proceeding, to the extent allowed by applicable law. The parties agree to not subpoena or otherwise require the mediator to testify or produce records, notes or work product in any future proceedings, and not recording or written record will be made during any mediation session(s). Evidence that is otherwise admissible or discoverable shall not be rendered inadmissible or non-discoverable as a result of its use in the mediation process. Information disclosed to the mediator in a private caucus shall remain confidential unless the parties authorize disclosure.

**e.** Upon demand for mediation, the parties shall select a mutually acceptable person or persons to serve as mediator. The mediator will not have any financial or personal interest in the outcome of the mediation and must disclose any circumstances which create a presumption of bias or cause delay in the mediation process.

**f.** All mediation proceedings shall take place at neutral location unless the parties agree otherwise. The parties will equally share the cost of the mediator. The parties will be responsible for their own reasonable costs related to a mediation proceeding.

**23. Termination.**

**a.** Notwithstanding the provisions in Section 14 and 15, if Contractor should fail to make satisfactory progress toward the completion of work under this Agreement, or should fail to make prompt payment for any materials, or to make payment to any subcontractors or labor, or should fail to comply with any applicable laws, rules or regulations, or otherwise violate any other provisions of this Agreement, then the Oneida Nation may immediately terminate this Agreement in part or in whole with written notice to Contractor. In the event of termination, the Oneida Nation may have the work completed by another contractor and may deduct the cost of completing the work from Contractor's Agreement Sum, and Contractor shall not have any further obligations to perform any work under this agreement. All warranties and indemnification shall survive this agreement.

b. Notwithstanding the provisions contained in this section, Oneida Nation shall otherwise have the right to terminate this Agreement with at least ten (10) business days' written notice to Contractor. The Oneida Nation shall then pay Contractor a proportionate amount of the Agreement Sum for the work completed, and Contractor shall not have any further obligations for any work performed under this Agreement.

**24. Other Terms and Conditions; Miscellaneous.**

a. The failure to insist upon performance of any term or condition of this Agreement, or to exercise any right or remedy shall not constitute a waiver of such term or condition. The waiver of any breach of any provision of this Agreement shall not be deemed a continuing waiver, and no delay in exercise of a right shall constitute a waiver.

b. This Agreement shall be construed and interpreted in accordance with the laws of the project location, without giving effect to any conflicts or choice of law principles. Any rule of construction that a document is to be construed against the drafting party shall not apply.

c. Nothing in this Agreement or attachments shall constitute or be construed as a waiver, express or implied, of the sovereign immunity of the Oneida Nation.

d. Nothing in this Agreement shall be construed to create a partnership or joint venture between the Oneida Nation and Contractor.

e. Contractor may not assign its rights and interests in this agreement without the Oneida Nation's express written consent. Any violation of this provision will be cause for immediate termination of this Agreement.

f. The section headings contained herein are for convenience of reference only and are not intended to define, limit, or describe the scope or intent of any provision of this Agreement. The section headings shall not be used in interpreting this agreement.

g. This Agreement may be executed in any number of counterparts, each of which shall be deemed to be an original and which shall together constitute one and the same Agreement.

h. This Agreement and any attachments hereto constitute the entire understanding and agreement between the parties. No modifications or amendments to this Agreement shall be binding unless made in writing between the parties.

i. The invalidity of any part of this Agreement shall not affect the remaining parts hereof.

j. In the event of any inconsistency or conflict between the Terms and Conditions of this Agreement and any attachments hereto, and any other terms and conditions not contained in this Agreement, this Agreement shall control.

**25. Notices.** All notices required by this Agreement will be in writing and sent in any commercially reasonable manner, including certified mail, return receipt requested, facsimile, or any other customary means of communication to the other party's representative at the applicable mailing address set forth below. Notices to the Oneida Nation shall be sent to the attention of person named below. Notices to Contractor shall be sent to the attention of the person named below. The effective date of any Notice shall be the date of personal service or three days after mailing. Any notice given otherwise than in accordance with this Article shall be deemed ineffective. Either party may change representative or address by written notice to the other party.

ONEIDA NATION:  
Oneida Nation - Engineering Dept.  
Attn:  
Engineering Director / Senior  
Architect  
Construction Manager

CONTRACTOR:  
Attn:

Post Office Box 365  
Oneida, WI 54155

IN WITNESS WHEREOF, Oneida Nation and Contractor have executed this Agreement on the date below.

ONEIDA NATION:

CONTRACTOR:

By: \_\_\_\_\_

By: \_\_\_\_\_

Engineering Director / Senior  
Architect Construction Manager

Date: \_\_\_\_\_

Date: \_\_\_\_\_

**Attachment A (Continued)**  
**Oneida Nation**  
**Exhibit A to Standard Construction Agreement**

**Compensation and Payment**

1. The Contract Sum is:

a.	Per Scope of Work:	\$	0.00
b.	???:	\$	0.00
c.	Total:	\$	0.00

2. Payments on account of services rendered shall be made monthly upon presentation of the Contractor's statement of services (schedule of values) in a format similar to AIA Documents G742 and G743.

- a. For each progress payment made prior to Substantial Completion of the Work, the Oneida Nation will withhold five percent (5%), as retainage, from the payment otherwise due.

3. See Exhibit D - ??? Bid (Quote) – Dated: ??, consisting of ?? pages.

**Scope of Work**

4. The Scope of Work shall be (incorporated herein by reference):

- a. Defined in the <project title>, #xx-xxx Project Manual, dated ??, as prepared by the Oneida Nation – Engineering Department, consisting of ?? pages.
- b. Include Addendum #1, dated ??, consisting of ?? pages.
- c. Include Addendum #2, dated ??, consisting of ?? pages.
- d. Voluntary Alternate: ?? is added to the scope of work.

Or

5. See Exhibit D - ??? Bid (Quote) – Dated: ??, consisting of ?? pages

6. The design professionals and consultants engaged by the Contractor are as follows:

- a. Architectural: ?
- b. Civil: n/a
- c. Structural: ?
- d. Fire Protection: ? – Design-Build
- e. Plumbing: ? – Design-Build
- f. HVAC: ? – Design-Build
- g. Electrical: ? – Design-Build

**Schedule of Exhibits**

7. Exhibit A – This page.

8. Exhibit B – Insurance Requirements:

# Oneida Nation Exhibit B Insurance Requirements

**CONTRACTOR INSURANCE**

- B.1. The Owner’s requirements for insurance coverage are denoted below.
- B.2. Indemnification, defense, protection and hold harmless shall exceed/survive all insurance available to Owner.
- B.3. Insurance provided to satisfy the terms of this agreement shall be on a primary and non-contributory basis and include a waiver of subrogation in favor of the Owner. Insurance shall extend until the State Statute of Repose.
- B.4. Contractor shall deliver to the Owner, certificates of insurance, and other evidence of insurance as requested, which Contractor is required to purchase and maintain. Such certificates of insurance shall include waivers of subrogation and denote Contractor’s insurance is on a primary and non-contributory basis.
  - B.4.1. Certificates verifying the required coverages shall be provided to the Owner prior to the Work being initiated.
- B.5. The insurance shall be written for not less than the following:
  - B.5.1. Workers’ Compensation:
 

B.5.1.1.	State	Statutory
B.5.1.2.	Applicable Federal (E.g., Longshoreman’s)	Statutory
B.5.1.3.	Employer’s Liability	\$ 100,000/500,000/100,000
  - B.5.2. Comprehensive General Liability (including Premises-Operations; Protective; Products and completed Operations: Broad Form Property Damage; Contractual Liability Insurance):
 

B.5.2.1.	General Aggregate	\$2,000,000
B.5.2.2.	Products Completed Aggregate	\$2,000,000
B.5.2.3.	Each Occurrence	\$1,000,000
B.5.2.4.	Personal Injury	\$1,000,000

    - B.5.2.5. Additional insured endorsement form CG2010, CG2037 or their equivalent must be submitted with each project.
  - B.5.3. Property Damage Liability Insurance shall include coverage for hazards X (explosion), C (collapse) and/or U (underground) as applicable.
  - B.5.4. Products and Completed Operations Insurance shall be maintained for one (1) year after Final Payment.
  - B.5.5. Umbrella Excess Liability \$5,000,000



9. Exhibit C – Conflict of Interest Disclosure Form.

**CONSULTANT/CONTRACTOR  
CONFLICT OF INTEREST  
DISCLOSURE FORM**

I, \_\_\_\_\_, **Name of Individual signing Disclosure Form**, on behalf of  
\_\_\_\_\_, **Name of Business, if any**

the "Contractor"), declare this to be a full and complete disclosure of all conflicts of interest with the Oneida Nation. Conflict of interest means any interest, whether it be personal, financial, political, or otherwise, that conflicts with any right of the Oneida Nation to property, information, or any other right to own and operate its enterprises, free from undisclosed competition or other violation of such rights of the Oneida Nation. Therefore, I affirm to the best of my knowledge the following:

1. The Contractor is not an employee of the Oneida Nation. *(Must include job description if employee of the Oneida Nation.)*
2. The Contractor is neither presently involved in, nor is it contemplating any legal actions against the Oneida Nation.
3. The Contractor is not presently involved in any activity or has any outside interests that conflict or suggest a potential conflict with the Oneida Nation.
4. The Contractor is neither involved in nor does it own any business investments which are related to or connected with the Oneida Nation, its programs, departments, or enterprises
5. Neither the Contractor, nor any of its representatives, holds any positions as director or officer in any public or private groups, firms, organizations, or other entities which are substantially or wholly owned by the Oneida Nation. No representative of the contractor sits on any board, commission, or committee of the Oneida Nation. No officer or director of the Company has any conflict as defined above
6. The Contractor is neither applying for, nor receiving, any special services, grants, loans or other programs provided by the Oneida Nation, and has no pending contracts with the Oneida Nation, except as herein disclosed and listed below:

**If NONE, please check**

**Enter disclosures, if any**

*(Attach additional pages, if necessary)*

During the term of the contract or any extension thereof, I will promptly report any situation which may involve, suggest or appear to suggest any conflict that I may have with the Oneida Nation. If a conflict arises, I am informed and understand that the Oneida Nation may in its sole discretion, terminate the contract without obligation to me. Further, failure to report any conflict shall also be cause to terminate my contract.

Signature: \_\_\_\_\_ Date: \_\_\_\_\_ **Date**

# Attachment B: Specifications

## **180 FT. LATTICE TOWER SPECIFICATIONS (NW Tower)**

Bidder will provide and install a 180 ft. lattice tower. The tower will not require aeronautical lighting or paint. The tower will be provided with a vertical cable ladder, cable ice bridge, climbing ladder with anti-climb cover, mobile and parabolic antenna mounts, and lightning rod assembly. Bidder will also provide:

1. The assembly and erection of the self-supporting tower and associated equipment and materials listed in above paragraph.
2. A climbing ladder and anti-fall device and shall provide two (1) full body climbing harness (per tower). Climbing ladder and safety climb system must meet EIA-222-H requirements.
3. The vertical ground conductor (No 2 AWG Cu) extending from the top-mounted lightning rod assembly down to ground level, bonded to ground bars to be mounted at 50-foot intervals. This conductor shall be bonded to the site ground system.
4. The exothermic molecular (Cadweld) bonding of the tower ground system to the tower legs, climbing ladder, vertical waveguide ladder, waveguide bridge support pipes, and two 24" ground bus bars (inside and outside the cable entrance window of the shelter).

Bidder is responsible for the design and construction of the tower and tower foundation. The tower foundation is to be designed for the total tower load that includes the antenna and transmission line loads listed below. The foundation design is to take into account the ultimate tower load specified above, as well as the soils report that will be distributed at the pre-bid conference.

Regardless of mode of transportation or F.O.B. designation, shipping and delivery costs shall be prepaid by the Bidder. The Bidder shall be responsible and accountable for the safe delivery of all goods to ONEIDA NATION.

Bidder shall furnish all transportation, handling, storage of materials, labor, tools, implements, machinery, supplies, materials, water, heat, utilities and incidentals, and shall do what is necessary to perform and complete the work.

Bidder shall ensure daily and at the completion of the installation that the working area is in order and clean. Bidder is responsible for securing the safety and security of all equipment and supplies left at the job site.

Bidder shall remove and properly dispose of all packing materials, shipping crates, concrete form work materials, and excess installation materials and hardware.

Bidder shall submit to ONEIDA NATION as soon as they are available from the tower vender, a complete set of the comprehensive tower and waveguide bridge drawings and the tower foundation design and construction notes.

The bidder must have at least ten (10) years' experience in the construction of telecommunications sites and towers.

ONEIDA NATION will review shop drawings and the tower engineering packet. The contractor shall submit the tower engineer's permitting package to ONEIDA NATION for approval prior to shipment of the tower. Prior to tower erection, the contractor shall submit the tower engineering and erection packages to ONEIDA NATION for approval. The engineering package shall be stamped by a structural or civil engineer, licensed in the State of Wisconsin.

A tribal construction permit will be required. The Tribal inspection department will monitor the project and inspect the foundation and tower. Additionally, the contractor shall hire a certified testing agency to perform concrete testing, with a minimum of a 7-day and 28 day compressive strength test, in addition to a slump test. The results shall meet the tower engineering requirements and be submitted to ONEIDA NATION for review and approval. If rock anchors are proposed, then a qualified inspector would have to inspect their placement. This inspector will be provided by the bidder and will be subject to the approval of ONEIDA NATION.

## **TOWER DESIGN**

The tower will be designed by or under the direct supervision of a registered and licensed professional engineer, specifically experienced in the design of communications towers.

The allowable unit stresses and the actual member stresses resulting from the specified design loads shall not exceed those given in the AISC specifications.

All members of the structure shall be considered primary members for the purpose of establishing allowable compressive stresses per AISC, except those members whose sole function is to reduce the  $kl/r$  ratio of the primary members.

For self-supporting tower footings, the safety factor for uplift shall be as described in EIA/TIA-222-H or latest revision.

Combined tower wind loads and antenna loads shall be applied in combination such that the maximum axial forces are produced in girts, diagonals and legs. Multiple analyses may be necessary to ensure that worst case design conditions have been investigated.

The design shall hold all antennas on path within the critical tower twist, sway, and displacement limits of EIA/TIA-222-H or latest revision.

The tower when fully loaded with the specified antenna assemblies, transmission lines, and other appurtenances, shall be designed in accordance with EIA/TIA-222-H or latest revision. The design for the tower shall use the ice loading value determined by EIA/TIA-222-H, for the site location.

The following EIA/TIA-222-H standards will apply: 1. Structure Classification: The design for the tower assumes risk category III. 2. Wind Exposure Category: The design for the tower should assume exposure category C, unless the tower engineer's analysis results in a recommendation for Exposure D. 3. Topographic

Category: The design for the tower shall use a topographic feature category determined by an evaluation of the tower site and its surroundings, based on ASCE standard practices.

## **FABRICATION & ASSEMBLY**

All fabrication, erection and identification of structural steel shall conform to AISC specifications.

Under no circumstances shall dissimilar metals be used in contact with one another for structural components.

Hot-dipped galvanizing of tubular sections shall be both inside and outside.

Welding processes and welding operators shall be qualified in accordance with AWS “Standard Qualification Procedure.”

Materials must be match-marked for field assembly. Fabricate for a delivery sequence which will expedite erection and minimize field handling of materials.

The Bidder shall specify a tower from one of two approved communication tower manufacturers:

1. Valmont/Microflect
2. Sabre
3. Rohn

No field welding, drilling or grinding shall be permitted unless specifically approved in writing.

All members shall be connected with galvanized structural bolts unless otherwise approved.

The tower will be provided with the correct size and length of anchor bolts necessary to carry the anticipated tower loads.

All threaded fasteners shall extend not less than 1-1/2 threads beyond nuts and locking devices.

## **CLIMBING LADDER**

The self-supporting tower shall be provided with an inside climbing ladder which will extend to the ground or to a platform one step above ground with an anti-fall device, meeting the requirement of ANSI 14.3.

The anti-fall device can be a safety cable, rail or pipe, positioned on the ladder so that climbing personnel can clip into the safety device attached to a safety climbing harness from the ground or platform.

To be provided is one (per lattice tower) safety climb harnesses with lanyard and rear back lanyard with a shock absorber conforming to all applicable safety requirements of CAL/OSHA requirements.

As a minimum, the inside climbing ladder shall conform to the following:

Climbing ladder rungs shall be minimum diameter  $\frac{3}{4}$  inches.

Distance between rungs shall not be more than 12 inches.

Minimum clear length of rungs shall be 16 inches.

Provide anti-climb panels that shall encompass both sides of the ladder. The panels shall be lockable but easily removed for authorized access.

The base of the ladder must be anchored to a concrete landing, per manufacturer's recommended design.

## **VERTICAL WAVEGUIDE LADDER**

The vertical waveguide ladder typically shall be 20 inches wide with ladder rung spaced vertically (ladder rung spacing may be between 36-inches (3 feet) and 42-inches (3.5 feet)) and with equally spaced factory drilled holes in the rungs with alternating  $\frac{3}{4}$  inch O.D. and  $\frac{7}{16}$ " inch drilled holes to support standard snap-in stainless steel hanger kits and the  $\frac{3}{8}$  inch hardware for securing standard bolt-on hanger kits. The waveguide ladder may be fixed to the inside of one or more of the tower faces.

The ladder shall secure to the tower with J-bolt hardware or equivalent hardware and run the distance from the tower top to just under the waveguide bridge.

If the bottom of the ladder extends down past the last horizontal tower member by more than 2 feet, then two (2) #2 bare solid copper cables shall be Cadwelded between both sides of the ladder and the next lowest tower facial member to provide a continuous downward path for lightning strike currents.

For wind loading design purposes, assume one layer for waveguide and no more than three layers for coaxial cables.

## **TOWER FINISHES**

All steel members and fasteners shall be hot-dipped galvanized with heavy zinc per standards in Section 4.0 of this specifications.

Under no circumstances shall any coating on any metal member or fastener be cathodic relative to the base material.

Use "Devcon," or equivalent, zinc rich paint, or approved equal, to touch up damaged galvanization or over Cadwelded ground cable connections to the tower members. Touch up may be done by either a spray or brush application.

## **TOWER LEG BASE GROUTING**

Immediately after tower erection and leveling nut adjustment Five Star Special Grout 100 or an approved non-shrink cementitious grout shall be mixed per manufacturer's recommendations and placed in between the bottom of each tower base plate and the top of the finished tower leg concrete foundation.

The drainage slot in the grout shall not be circular but triangular in cross section as made with a 1 ½" x 1 ½" angle.

## **LIGHTNING PROTECTION AND GROUNDING**

Tower top shall be equipped with a 15 ft. lightning rod assembly available from the Valmont/Microflect Company (or equivalent) for pipe-to-pipe mounting onto a top mounted 2-3/8 inch O.D. vertical top pipe mount.

Each tower leg shall be equipped with a tab or a point to Cadweld one 2/0 bare stranded copper ground cables that shall be installed to the buried tower ground system.

The base of the climbing ladder shall be Cadwelded with a 2/0 bare solid copper ground cable as provided by the tower foundation contractor that shall be connected to the buried ground system.

The base of the waveguide bridge support columns shall be Cadwelded with 2/0 bare stranded copper ground cables that shall be connected to the buried ground system.

Cadweld mold kits and weld metal shall be provided by the contractor unless specified by ONEIDA NATION. Field fabricated molds are unacceptable. All Cadwelds shall be performed in accordance to the vendor specifications and instructions to ensure good Cadwelds.

A single 20-foot concrete encased (Ufer) ground electrode shall be provided and installed with the tower foundation. The specific orientation may vary, depending on the proposed foundation design. However, the steel electrode must extend above the concrete a minimum of six inches to allow an exothermically welded connection to the tower ground ring conductors. An electrical connection shall be made to the Ufer electrode only as required by the local jurisdiction.

A 24-inch (or larger) ground bus bar shall be mounted on the tower, using insulated mounts, in-line with the cable ladder at a height of 15 to 20 feet above ground level. Twelve-inch (or larger) ground bus bars shall be installed at 50-foot intervals above the first, plus one near the top. These ground bars shall be connected to the tower ground system using a no.2 solid Cu conductor, which is exothermically welded to each bus bar.

## **ANTENNA TOWER MOUNTS**

4-1/2" O.D. pipe mounts shall be supplied and installed at the position specified for each microwave antenna in the antenna list specified.

2-3/8”inch O.D. vertical pipe mounts shall be supplied and installed on the top of each tower leg top plate for the support of mobile radio antennas and lightning rod assembly.

Other mounts shall be provided, as called-out in the antenna list

Tower pipe mounts shall be plumb in each axis unless specified otherwise.

The 4.5 inch O.D. pipe mounts shall be positioned on the outside of each tower leg to prevent the parabolic antenna rear feed horn assembly from being directly opposite a tower leg member. Tower pipe mount positioning shall not prevent direct waveguide or coaxial installation to any parabolic antenna.

## TOWER LOADING

The structural design of the tower and foundation shall accommodate all specified loads, including the specified antennas, feedlines, and “future” loads.

For all vertical side-mounted antennas, assume one 24-inch stand-off mount and one tip support per antenna, for loading calculations. Vertical antennas shall use a 2-3/8 inch pipe mount.

For all microwave antennas 4-feet or larger in diameter, a 4-1/2 inch pipe mount shall be assumed. For smaller microwave antennas, a smaller mount (or the manufacturer’s recommended mount) shall be assumed.

All 2-3/8” pipe mounts and all 4-1/2” pipe mounts, listed as “2023” shall be provided with the tower. Antennas and transmission lines will be installed, by others, under a separate contract. Platform and mounts for cellular antennas will not be required with the tower.

### *Tower Loading information*

180' Northwest Tower						
Height	Quantity	Description	Installation Date	Azimuth	Mount	Transmission Line
195' (tip)	1	Top Mounted lightning rod & downlead (No 2)	2023	N/A	Top mount	No 2 AWG
191' (tip)	3	DS7C09P36UD Antenna and 434B TTA	2023	20/120/260	Commscope S-600 (3x), or equal	7/8" AVA5-50 Heliac
160'	3	Erickson Air4435	2023	20/120/260	(3x) 2-3/8" pipe mount	(3x) No 2 Gnd, (12x) Armored Fiber
150'	1	Cellular platform w/ (9x) 6-foot panels (typ)	future	20/120/260		(9x) 1-5/8" Heliac
135'	1	6-foot UHX Microwave Antenna	2023	88.2	4-1/2" Pipe Mount	EW-90 Waveguide
100'	1	6-foot UHX Microwave Antenna	future	88.2	4-1/2" Pipe Mount	EW-63 Waveguide
100'	1	6-foot UHX Microwave Antenna	future	178.5	4-1/2" Pipe Mount	EW-63 Waveguide
75'	1	6-foot UHX Microwave Antenna	2023	178.5	4-1/2" Pipe Mount	EW-90 Waveguide
		MOUNTS TO BE PROVIDED WITH TOWER				
		MOUNTS ARE FUTURE				

## HORIZONTAL WAVEGUIDE BRIDGE

The waveguide bridge shall be provided between the tower and the Transmission Line Service Entrance on the radio building wall, as shown on the plans, and engineered to provide horizontal support of waveguide and coaxial feedlines.

The waveguide bridge shall be 24 inches wide and shall be suitably attached and supported only to its support pipes independent of the radio shelter and tower, and shall have sufficient strength to support two 250 pound persons and shall ensure that no damage is sustained by a falling one cubic foot block of ice from the top of the tower. The ice bridge should be fully supported by a minimum of two pairs of pipe columns.

The horizontal support of the feedlines under the waveguide bridge shall be via a two tier galvanized angle trapeze, with combination  $\frac{3}{4}$  inch O.D. and  $\frac{7}{16}$  inch drilled holes for the securement of hanger kits, with each end supported vertically from the overhead waveguide bridge channel via  $\frac{3}{8}$  inch galvanized threaded rods. These hanger kit support frames shall be spaced horizontally every 3 feet under the waveguide bridge.

## **TOWER DOCUMENTATION REPORT**

A complete and orderly summary of the tower stress analysis showing loading considerations, tower base reactions, member sizes, allowable stresses and maximum computed forces in members is required for the tower. The analysis is to be certified by a registered professional engineer with experience in tower design.

Complete installation drawings are required at the conclusion of the project, complete with as-built corrections reflecting the completed installation.

Before submitting drawings or other data to ONEIDA NATION it shall be the sole responsibility of the Bidder to comprehensively and thoroughly check same for accuracy and full compliance with plans and specifications and proper form, fit and function.

Where a specific material, process, or product is specified, and the Bidder desires to provide an improvement or equal, he shall submit a statement to this effect to ONEIDA NATION.

Tower manufacturer shall provide the tower foundation design based on the soils survey and soils report. The foundation design shall be signed by a registered professional engineer.

### **100 FT. LATTICE TOWER SPECIFICATIONS (Public Safety Tower)**

Bidder will provide and install a 100 ft. lattice tower. The tower will not require aeronautical lighting or paint. The tower will be provided with a vertical cable ladder, cable ice bridge, climbing ladder with anti-climb cover, mobile and parabolic antenna mounts, and lightning rod assembly. Bidder will also provide:

1. The assembly and erection of the self-supporting tower and associated equipment and materials listed in above paragraph.
2. A climbing ladder and anti-fall device and shall provide two (1) full body climbing harness (per tower). Climbing ladder and safety climb system must meet EIA-222-H requirements.
3. The vertical ground conductor (No 2 AWG Cu) extending from the top-mounted lightning rod assembly down to ground level, bonded to ground bars to be mounted at 50-foot intervals. This conductor shall be bonded to the site ground system.



4. The exothermic molecular (Cadweld) bonding of the tower ground system to the tower legs, climbing ladder, vertical waveguide ladder, waveguide bridge support pipes, and two 24” ground bus bars (inside and outside the cable entrance window of the shelter).

Bidder is responsible for the design and construction of the tower and tower foundation. The tower foundation is to be designed for the total tower load that includes the antenna and transmission line loads listed below. The foundation design is to take into account the ultimate tower load specified above, as well as the soils report that will be distributed at the pre-bid conference.

Regardless of mode of transportation or F.O.B. designation, shipping and delivery costs shall be prepaid by the Bidder. The Bidder shall be responsible and accountable for the safe delivery of all goods to ONEIDA NATION.

Bidder shall furnish all transportation, handling, storage of materials, labor, tools, implements, machinery, supplies, materials, water, heat, utilities and incidentals, and shall do what is necessary to perform and complete the work.

Bidder shall ensure daily and at the completion of the installation that the working area is in order and clean. Bidder is responsible for securing the safety and security of all equipment and supplies left at the job site.

Bidder shall remove and properly dispose of all packing materials, shipping crates, concrete form work materials, and excess installation materials and hardware.

Bidder shall submit to ONEIDA NATION as soon as they are available from the tower vender, a complete set of the comprehensive tower and waveguide bridge drawings and the tower foundation design and construction notes.

The bidder must have at least ten (10) years’ experience in the construction of telecommunications sites and towers.

ONEIDA NATION will review shop drawings and the tower engineering packet. The contractor shall submit the tower engineer's permitting package to ONEIDA NATION for approval prior to shipment of the tower. Prior to tower erection, the contractor shall submit the tower engineering and erection packages to ONEIDA NATION for approval. The engineering package shall be stamped by a structural or civil engineer, licensed in the State of Wisconsin.

A tribal construction permit will be required. The Tribal inspection department will monitor the project and inspect the foundation and tower. Additionally, the contractor shall hire a certified testing agency to perform concrete testing, with a minimum of a 7-day and 28 day compressive strength test, in addition to a slump test. The results shall meet the tower engineering requirements and be submitted to ONEIDA NATION for review and approval. If rock anchors are proposed, then a qualified inspector would have to inspect their placement. This inspector will be provided by the bidder and will be subject to the approval of ONEIDA NATION.

## **TOWER DESIGN**

The tower will be designed by or under the direct supervision of a registered and licensed professional engineer, specifically experienced in the design of communications towers.

The allowable unit stresses and the actual member stresses resulting from the specified design loads shall not exceed those given in the AISC specifications.

All members of the structure shall be considered primary members for the purpose of establishing allowable compressive stresses per AISC, except those members whose sole function is to reduce the  $kl/r$  ratio of the primary members.

For self-supporting tower footings, the safety factor for uplift shall be as described in EIA/TIA-222-H or latest revision.

Combined tower wind loads and antenna loads shall be applied in combination such that the maximum axial forces are produced in girts, diagonals and legs. Multiple analyses may be necessary to ensure that worst case design conditions have been investigated.

The design shall hold all antennas on path within the critical tower twist, sway, and displacement limits of EIA/TIA-222-H or latest revision.

The tower when fully loaded with the specified antenna assemblies, transmission lines, and other appurtenances, shall be designed in accordance with EIA/TIA-222-H or latest revision. The design for the tower shall use the ice loading value determined by EIA/TIA-222-H, for the site location.

The following EIA/TIA-222-H standards will apply: 1. Structure Classification: The design for the tower assumes risk category III. 2. Wind Exposure Category: The design for the tower should assume exposure category C, unless the tower engineer's analysis results in a recommendation for Exposure D. 3. Topographic Category: The design for the tower shall use a topographic feature category determined by an evaluation of the tower site and its surroundings, based on ASCE standard practices.

## **FABRICATION & ASSEMBLY**

All fabrication, erection and identification of structural steel shall conform to AISC specifications.

Under no circumstances shall dissimilar metals be used in contact with one another for structural components.

Hot-dipped galvanizing of tubular sections shall be both inside and outside.

Welding processes and welding operators shall be qualified in accordance with AWS "Standard Qualification Procedure."

Materials must be match-marked for field assembly. Fabricate for a delivery sequence which will expedite erection and minimize field handling of materials.

The Bidder shall specify a tower from one of two approved communication tower manufacturers:

1. Valmont/Microflect

2. Sabre

3. Rohn

No field welding, drilling or grinding shall be permitted unless specifically approved in writing.

All members shall be connected with galvanized structural bolts unless otherwise approved.

The tower will be provided with the correct size and length of anchor bolts necessary to carry the anticipated tower loads.

All threaded fasteners shall extend not less than 1-1/2 threads beyond nuts and locking devices.

## **CLIMBING LADDER**

The self-supporting tower shall be provided with an inside climbing ladder which will extend to the ground or to a platform one step above ground with an anti-fall device, meeting the requirement of ANSI 14.3.

The anti-fall device can be a safety cable, rail or pipe, positioned on the ladder so that climbing personnel can clip into the safety device attached to a safety climbing harness from the ground or platform.

To be provided is one (per lattice tower) safety climb harnesses with lanyard and rear back lanyard with a shock absorber conforming to all applicable safety requirements of CAL/OSHA requirements.

As a minimum, the inside climbing ladder shall conform to the following:

Climbing ladder rungs shall be minimum diameter  $\frac{3}{4}$  inches.

Distance between rungs shall not be more than 12 inches.

Minimum clear length of rungs shall be 16 inches.

Provide anti-climb panels that shall encompass both sides of the ladder. The panels shall be lockable but easily removed for authorized access.

The base of the ladder must be anchored to a concrete landing, per manufacturer's recommended design.

## **VERTICAL WAVEGUIDE LADDER**

The vertical waveguide ladder typically shall be 20 inches wide with ladder rung spaced vertically (ladder rung spacing may be between 36-inches (3 feet) and 42-inches (3.5 feet)) and with equally spaced factory drilled holes in the rungs with alternating  $\frac{3}{4}$  inch O.D. and  $\frac{7}{16}$ " inch drilled holes to support standard snap-in stainless steel hanger kits and the  $\frac{3}{8}$  inch hardware for securing standard bolt-on hanger kits. The waveguide ladder may be fixed to the inside of one or more of the tower faces.

The ladder shall secure to the tower with J-bolt hardware or equivalent hardware and run the distance from the tower top to just under the waveguide bridge.

If the bottom of the ladder extends down past the last horizontal tower member by more than 2 feet, then two (2) #2 bare solid copper cables shall be Cadwelded between both sides of the ladder and the next lowest tower facial member to provide a continuous downward path for lightning strike currents.

For wind loading design purposes, assume one layer for waveguide and no more than three layers for coaxial cables.

## **TOWER FINISHES**

All steel members and fasteners shall be hot-dipped galvanized with heavy zinc per standards in Section 4.0 of this specifications.

Under no circumstances shall any coating on any metal member or fastener be cathodic relative to the base material.

Use “Devcon,” or equivalent, zinc rich paint, or approved equal, to touch up damaged galvanization or over Cadwelded ground cable connections to the tower members. Touch up may be done by either a spray or brush application.

## **TOWER LEG BASE GROUTING**

Immediately after tower erection and leveling nut adjustment Five Star Special Grout 100 or an approved non-shrink cementitious grout shall be mixed per manufacturer’s recommendations and placed in between the bottom of each tower base plate and the top of the finished tower leg concrete foundation.

The drainage slot in the grout shall not be circular but triangular in cross section as made with a 1 ½” x 1 ½” angle.

## **LIGHTNING PROTECTION AND GROUNDING**

Tower top shall be equipped with a 15 ft. lightning rod assembly available from the Valmont/Microflect Company (or equivalent) for pipe-to-pipe mounting onto a top mounted 2-3/8 inch O.D. vertical top pipe mount.

Each tower leg shall be equipped with a tab or a point to Cadweld one 2/0 bare stranded copper ground cables that shall be installed to the buried tower ground system.

The base of the climbing ladder shall be Cadwelded with a 2/0 bare solid copper ground cable as provided by the tower foundation contractor that shall be connected to the buried ground system.

The base of the waveguide bridge support columns shall be Cadwelded with 2/0 bare stranded copper ground cables that shall be connected to the buried ground system.

Cadweld mold kits and weld metal shall be provided by the contractor unless specified by ONEIDA NATION. Field fabricated molds are unacceptable. All Cadwelds shall be performed in accordance to the vendor specifications and instructions to ensure good Cadwelds.

A single 20-foot concrete encased (Ufer) ground electrode shall be provided and installed with the tower foundation. The specific orientation may vary, depending on the proposed foundation design. However, the steel electrode must extend above the concrete a minimum of six inches to allow an exothermically welded connection to the tower ground ring conductors. An electrical connection shall be made to the Ufer electrode only as required by the local jurisdiction.

A 24-inch (or larger) ground bus bar shall be mounted on the tower, using insulated mounts, in-line with the cable ladder at a height of 15 to 20 feet above ground level. Twelve-inch (or larger) ground bus bars shall be installed at 50-foot intervals above the first, plus one near the top. These ground bars shall be connected to the tower ground system using a no.2 solid Cu conductor, which is exothermically welded to each bus bar.

## **ANTENNA TOWER MOUNTS**

4-1/2" O.D. pipe mounts shall be supplied and installed at the position specified for each microwave antenna in the antenna list specified.

2-3/8"inch O.D. vertical pipe mounts shall be supplied and installed on the top of each tower leg top plate for the support of mobile radio antennas and lightning rod assembly.

Other mounts shall be provided, as called-out in the antenna list

Tower pipe mounts shall be plumb in each axis unless specified otherwise.

The 4.5 inch O.D. pipe mounts shall be positioned on the outside of each tower leg to prevent the parabolic antenna rear feed horn assembly from being directly opposite a tower leg member. Tower pipe mount positioning shall not prevent direct waveguide or coaxial installation to any parabolic antenna.

## **TOWER LOADING**

The structural design of the tower and foundation shall accommodate all specified loads, including the specified antennas, feedlines, and "future" loads.

For all vertical side-mounted antennas, assume one 24-inch stand-off mount and one tip support per antenna, for loading calculations. Vertical antennas shall use a 2-3/8 inch pipe mount.

For all microwave antennas 4-feet or larger in diameter, a 4-1/2 inch pipe mount shall be assumed. For smaller microwave antennas, a smaller mount (or the manufacturer's recommended mount) shall be assumed.

All 2-3/8” pipe mounts and all 4-1/2” pipe mounts, listed as “2023” shall be provided with the tower. Antennas and transmission lines will be installed, by others, under a separate contract. Platform and mounts for cellular antennas will not be required with the tower.

*Tower Loading Information*

100' Public Safety Tower						
Height	Quantity	Description	Installation Date	Azimuth	Mount	Transmission Line
112' (tip)	1	Top Mounted lightning rod & downlead (No 2)	2023	N/A	Top mount	No 2 AWG
111' (tip)	3	DS7C09P36UD Antenna and 434B TTA	2023	20/120/260	Commscope S-600 (3x), or equal	7/8" AVA5-50 Heliac
90'	3	Erickson Air4435	2023	20/120/260	(3x) 2-3/8" pipe mount	(3x) No 2 Gnd, (12x) Armored Fiber
75'	1	Cellular platform w/ (9x) 6-foot panels (typ)	future	20/120/260		(9x) 1-5/8" Heliac
65'	1	8-foot UHX Microwave Antenna	future	178.5	4-1/2" Pipe Mount	EW-63 Waveguide
65'	1	6-foot UHX Microwave Antenna	2023	358.5	4-1/2" Pipe Mount	EW-90 Waveguide
60'	1	8-foot UHX Microwave Antenna	2023	48.8	4-1/2" Pipe Mount	EW-90 Waveguide
		Mounts to be provided with tower				
		Mounts are future				

**HORIZONTAL WAVEGUIDE BRIDGE**

The waveguide bridge shall be provided between the tower and the Transmission Line Service Entrance on the radio building wall, as shown on the plans, and engineered to provide horizontal support of waveguide and coaxial feedlines.

The waveguide bridge shall be 24 inches wide and shall be suitably attached and supported only to its support pipes independent of the radio shelter and tower, and shall have sufficient strength to support two 250 pound persons and shall ensure that no damage is sustained by a falling one cubic foot block of ice from the top of the tower. The ice bridge should be fully supported by a minimum of two pairs of pipe columns.

The horizontal support of the feedlines under the waveguide bridge shall be via a two tier galvanized angle trapeze, with combination 3/4 inch O.D. and 7/16 inch drilled holes for the securement of hanger kits, with each end supported vertically from the overhead waveguide bridge channel via 3/8 inch galvanized threaded rods. These hanger kit support frames shall be spaced horizontally every 3 feet under the waveguide bridge.

**TOWER DOCUMENTATION REPORT**

A complete and orderly summary of the tower stress analysis showing loading considerations, tower base reactions, member sizes, allowable stresses and maximum computed forces in members is required for the tower. The analysis is to be certified by a registered professional engineer with experience in tower design.

Complete installation drawings are required at the conclusion of the project, complete with as-built corrections reflecting the completed installation.

Before submitting drawings or other data to ONEIDA NATION it shall be the sole responsibility of the Bidder to comprehensively and thoroughly check same for accuracy and full compliance with plans and specifications and proper form, fit and function.

Where a specific material, process, or product is specified, and the Bidder desires to provide an improvement or equal, he shall submit a statement to this effect to ONEIDA NATION.

Tower manufacturer shall provide the tower foundation design based on the soils survey and soils report. The foundation design shall be signed by a registered professional engineer.

### **150 FT. MONOPOLE TOWER SPECIFICATIONS (Skenandoah Tower)**

Height of the monopole tower will be 150 feet. The tower will not require aeronautical lighting or paint. The tower will be provided with a vertical waveguide ladder, waveguide ice bridge, climbing steps (omitted for the lowest 15-feet), mobile and parabolic antenna tower mounts, and lightning rod assembly. Bidder will also provide:

1. The assembly and erection of the self-supporting tower and associated equipment and materials listed in paragraph 1 above.
2. A climbing ladder and anti-fall device and shall provide two (2) full body climbing harnesses (per tower). Climbing steps and safety climb system must meet EIA-222-H requirements.
3. The vertical ground conductor (No 2 AWG Cu) extending from the top-mounted lightning rod assembly down to ground level, bonded to ground bars to be mounted at 50-foot intervals. This conductor shall be bonded to the site ground system.
4. The exothermic molecular (Cadweld) bonding of the tower ground system to the monopole, vertical waveguide ladder, and waveguide bridge support pipes.

Bidder is responsible for the design and construction of the tower and foundation. The tower foundation is to be designed for the total tower load that includes the antenna and transmission line loads listed below. The foundation design is to take into account the ultimate tower load specified above, as well as the soils report that will be distributed at the pre-bid conference.

Regardless of mode of transportation or F.O.B. designation, shipping and delivery costs shall be prepaid by the Bidder. The Bidder shall be responsible and accountable for the safe delivery of all goods to ONEIDA NATION.

Bidder shall furnish all transportation, handling, storage of materials, labor, tools, implements, machinery, supplies, materials, water, heat, utilities and incidentals, and shall do what is necessary to perform and complete the work.

Bidder shall ensure daily and at the completion of the installation that the working area is in order and clean. Bidder is responsible for securing the safety and security of all equipment and supplies left at the job site.

Bidder shall remove and properly dispose of all packing materials, shipping crates, concrete form work materials, and excess installation materials and hardware.

Bidder shall submit to ONEIDA NATION as soon as they are available from the tower vender, a complete set of the comprehensive tower and waveguide bridge drawings and the tower foundation design and construction notes.

The bidder must have at least ten (10) years' experience in the construction of telecommunications sites and towers.

ONEIDA NATION will review shop drawings and the tower engineering packet. The contractor shall submit the tower engineer's permitting package to ONEIDA NATION for approval prior to shipment of the tower. Prior to tower erection, the contractor shall submit the tower engineering and erection packages to ONEIDA NATION for approval. The engineering package shall be stamped by a structural or civil engineer, licensed in the State of Wisconsin.

A tribal construction permit will be required. The Tribal inspection department will monitor the project and inspect the foundation and tower. Additionally, the contractor shall hire a certified testing agency to perform concrete testing, with a minimum of a 7-day and 28 day compressive strength test, in addition to a slump test. The results shall meet the tower engineering requirements and be submitted to ONEIDA NATION for review and approval. If rock anchors are proposed, then a qualified inspector would have to inspect their placement. This inspector will be provided by the bidder and will be subject to the approval of ONEIDA NATION.

## **TOWER DESIGN**

The tower will be designed by or under the direct supervision of a registered and licensed professional engineer, specifically experienced in the design of communications towers.

The allowable unit stresses and the actual member stresses resulting from the specified design loads shall not exceed those given in the AISC specifications.

All members of the structure shall be considered primary members for the purpose of establishing allowable compressive stresses per AISC, except those members whose sole function is to reduce the  $kl/r$  ratio of the primary members.

For self-supporting tower footings, the safety factor for uplift shall be as described in EIA/TIA-222-H or latest revision.

Combined tower wind loads and antenna loads shall be applied in combination such that the maximum axial forces are produced in girts, diagonals and legs. Multiple analyses may be necessary to ensure that worst case design conditions have been investigated.

The design shall hold all antennas on path within the critical tower twist, sway, and displacement limits of EIA/TIA-222-H or latest revision.



The tower when fully loaded with the specified antenna assemblies, transmission lines, and other appurtenances, shall be designed in accordance with EIA/TIA-222-H or latest revision. The design for the tower shall use the ice loading value determined by EIA/TIA-222-H, for the site location.

The following EIA/TIA-222-H standards will apply: 1. Structure Classification: The design for the tower assumes risk category III. 2. Wind Exposure Category: The design for the tower should assume exposure category C, unless the tower engineer's analysis results in a recommendation for Exposure D. 3. Topographic Category: The design for the tower shall use a topographic feature category determined by an evaluation of the tower site and its surroundings, based on ASCE standard practices.

## **FABRICATION & ASSEMBLY**

All fabrication, erection and identification of structural steel shall conform to AISC specifications.

Under no circumstances shall dissimilar metals be used in contact with one another for structural components.

Hot-dipped galvanizing of tubular sections shall be both inside and outside.

Welding processes and welding operators shall be qualified in accordance with AWS "Standard Qualification Procedure."

Materials must be match-marked for field assembly. Fabricate for a delivery sequence which will expedite erection and minimize field handling of materials.

The Bidder shall specify a monopole from one of two approved communication tower manufacturers:

1. Valmont/Microfect
2. Sabre
3. Rohn

No field welding, drilling or grinding shall be permitted unless specifically approved in writing.

All members shall be connected with galvanized structural bolts unless otherwise approved.

The monopole will be provided with the correct size and length of anchor bolts necessary to carry the anticipated tower loads.

All threaded fasteners shall extend not less than 1-1/2 threads beyond nuts and locking devices.

## **CLIMBING PEGS**

The monopole shall be provided with climbing pegs which will extend from 15-feet above ground to the top, including an anti-fall device, meeting the requirement of ANSI 14.3.

The anti-fall device can be a safety cable, rail or pipe, positioned on the ladder so that climbing personnel can clip into the safety device attached to a safety climbing harness from the ground or platform.

To be provided are two sets of safety climb harnesses with lanyard and rear back lanyard with a shock absorber conforming to all applicable safety requirements of CAL/OSHA requirements.

## **VERTICAL WAVEGUIDE LADDER**

The vertical waveguide ladder typically shall be 12 inches wide with ladder rung spaced vertically (ladder rung spacing may be between 36-inches (3 feet) and 42-inches (3.5 feet)) and with equally spaced factory drilled holes in the rungs with alternating  $\frac{3}{4}$  inch O.D. and  $\frac{7}{16}$  inch drilled holes to support standard snap-in stainless steel hanger kits and the  $\frac{3}{8}$  inch hardware for securing standard bolt-on hanger kits. The waveguide ladder may be fixed to the outside of the monopole.

The ladder shall secure to the tower with galvanized hardware and run the distance from the highest listed microwave antenna to just under the waveguide bridge.

For wind loading design purposes, assume one layer for waveguide and no more than three layers for coaxial cables.

Coaxial cables, and data cables specified for the upper antennas may be designed to run inside the monopole, provided that appropriate access holes and hangers are provided at the levels called out for the associated antennas.

## **TOWER FINISHES**

All steel members and fasteners shall be hot-dipped galvanized with heavy zinc per standards in Section 4.0 of this specifications.

Under no circumstances shall any coating on any metal member or fastener be cathodic relative to the base material.

Use “Devcon,” or equivalent, zinc rich paint, or approved equal, to touch up damaged galvanization or over Cadwelded ground cable connections to the tower members. Touch up may be done by either a spray or brush application.

## **TOWER LEG BASE GROUTING**

Immediately after erection and leveling nut adjustment Five Star Special Grout 100 or an approved non-shrink cementitious grout shall be mixed per manufacturer’s recommendations and placed in between the bottom of the monopole base plate and the top of the finished concrete foundation.

The drainage slot in the grout shall not be circular but triangular in cross section as made with a 1 ½” x 1 ½” angle.

## **LIGHTNING PROTECTION AND GROUNDING**

The monopole top shall be equipped with a 15 ft. lightning rod assembly available from the Valmont/Microflect Company (or equivalent) for pipe-to-pipe mounting onto a top mounted 2-3/8 inch O.D. vertical top pipe mount.

The monopole shall be equipped with four tabs or points, each to Cadweld one 2/0 bare stranded copper ground cable that shall be installed to the buried tower ground system.

The base of the climbing ladder shall be Cadwelded with a 2/0 bare solid copper ground cable as provided by the tower foundation contractor that shall be connected to the buried ground system.

The base of the waveguide bridge support columns shall be Cadwelded with 2/0 bare stranded copper ground cables that shall be connected to the buried ground system.

Cadweld mold kits and weld metal shall be provided by the contractor unless specified by ONEIDA NATION. Field fabricated molds are unacceptable. All Cadwelds shall be performed in accordance to the vendor specifications and instructions to ensure good Cadwelds.

A single 20-foot concrete encased (Ufer) ground electrode shall be provided and installed with the foundation. The specific orientation may vary, depending on the proposed foundation design. However, the steel electrode must extend above the concrete a minimum of six inches to allow an exothermically welded connection to the tower ground ring conductors. An electrical connection shall be made to the Ufer electrode only as required by the local jurisdiction.

A 12-inch (or larger) ground bus bar shall be mounted on the tower, using insulated mounts, in-line with the cable ladder at a height of 15 to 20 feet above ground level. Twelve-inch (or larger) ground bus bars shall be installed at 50-foot intervals above the first, plus one near the top. These ground bars shall be connected to the tower ground system using a no.2 solid Cu conductor, which is exothermically welded to each bus bar.

## **ANTENNA TOWER MOUNTS**

The monopole shall be fabricated with bolted connections for each mount listed, including “future” mounts (chain-mounts are not allowed).

4-1/2” O.D. pipe mounts shall be supplied and installed at the position specified for each microwave antenna in the antenna list specified.

2-3/8” inch O.D. vertical pipe mounts shall be supplied and installed on the top of each tower leg top plate for the support of mobile radio antennas and Microflect lightning rod assembly.

All pipe mounts shall be plumb in each axis unless specified otherwise.

## TOWER LOADING

The structural design of the monopole and foundation shall accommodate all specified loads, including the specified antennas, feedlines, and “future” loads.

For all vertical side-mounted antennas, assume one 24-inch stand-off mount and one tip support per antenna, for loading calculations. Vertical antennas shall use a 2-3/8 inch pipe mount.

For all microwave antennas 4-feet or larger in diameter, a 4-1/2 inch pipe mount shall be assumed. For smaller microwave antennas, a smaller mount (or the manufacturer’s recommended mount) shall be assumed.

All 2-3/8” pipe mounts and all 4-1/2” pipe mounts, listed as “2023” shall be provided with the tower. Antennas and transmission lines will be installed, by others, under a separate contract.

### *Tower Loading information*

150-foot monopole						
Height	Quantity	Description	Installation Date	Azimuth	Mount	Transmission Line
165' (tip)	1	Top Mounted lightning rod & downlead (No 2)	2023	N/A	Top mount	No 2 AWG
161' (tip)	12	DS7C09P36UD Antenna and 434B TTA	(3x) 2023 / (9x) future	270	Valmont RMQP-496-HK	7/8" AVA5-50 Helix
150'	1	Tower top test receive preamplifier	2023	N/A	Top mount	1/2" LDF4-50 Helix
120'	1	8-foot UHX Microwave Antenna	future	220	4-1/2" Pipe Mount	EW-63 Waveguide
110'	1	6-foot UHX Microwave Antenna	2023	268.2	4-1/2" Pipe Mount	EW-90 Waveguide
100'	1	6-foot UHX Microwave Antenna	2023	228.8	4-1/2" Pipe Mount	EW-90 Waveguide
		Mounts to be provided with tower				
		Mounts are future				

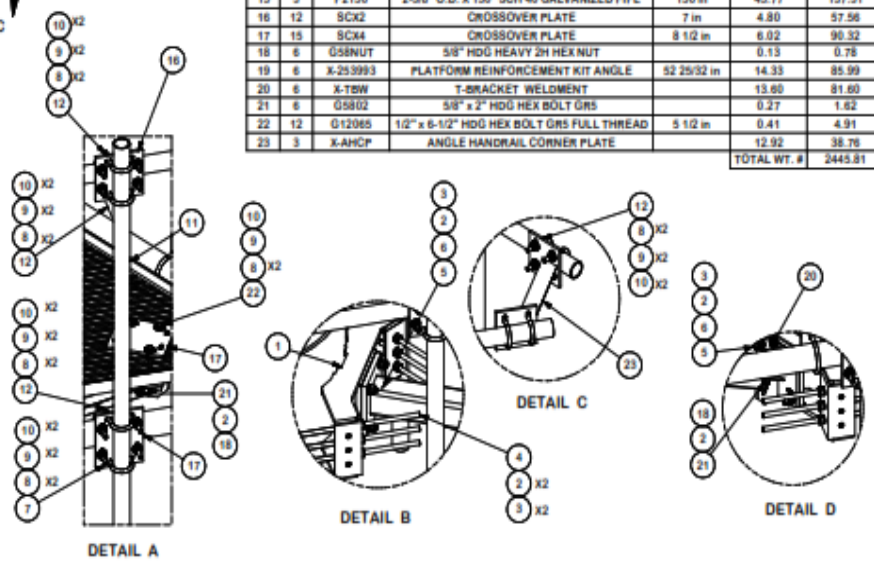
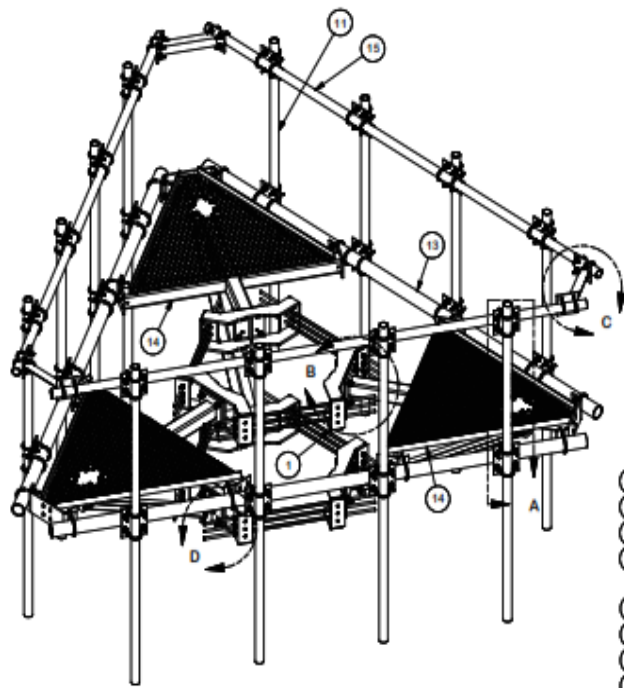

PARTS LIST						
ITEM	QTY	PART NO.	PART DESCRIPTION	LENGTH	UNIT WT.	NET WT.
1	6	X-LWRM	RING MOUNT WELDMENT		66.81	412.85
2	66	G58LW	5/8" HDG LOCKWASHER		0.03	1.72
3	60	A58NUT	5/8" HDG A325 HEX NUT		0.13	7.79
4	18	G58R-24	5/8" x 24" THREADED ROD (HDG.)		2.09	37.63
4	18	G58R-48	5/8" x 48" THREADED ROD (HDG.)		4.18	75.27
5	24	A58234	5/8" x 2-3/4" HDG A325 HEX BOLT	2 3/4 in	0.36	8.54
6	24	A58FW	5/8" HDG A325 FLATWASHER		0.03	0.82
7	36	X-UB1306	1/2" X 3-5/8" X 6" X 3" U-BOLT (HDG.)		0.83	29.82
8	264	G12FW	1/2" HDG USS FLATWASHER	3/32 in	0.03	9.00
9	252	G12LW	1/2" HDG LOCKWASHER	1/8 in	0.01	3.50
10	252	G12NUT	1/2" HDG HEAVY 2H HEX NUT		0.07	18.05
11	12	P236	2-3/8" X 96" SCH. 40 GALVANIZED PIPE	96 in	30.76	369.08
12	84	X-UB1212	1/2" X 2-1/2" X 4-1/2" X 2" U-BOLT (HDG.)		0.63	52.51
13	3	P3150	3-1/2" X 150" (3" SCH 40) GALVANIZED PIPE	150 in	94.80	284.40
14	3	X-SV196	LOW PROFILE PLATFORM CORNER		212.10	636.31
15	3	P2150	3-3/8" O.D. X 150" SCH 40 GALVANIZED PIPE	150 in	45.77	137.31
16	12	SCX2	CROSSOVER PLATE	7 in	4.80	57.56
17	15	SCX4	CROSSOVER PLATE	8 1/2 in	6.02	90.32
18	6	G58NUT	5/8" HDG HEAVY 2H HEX NUT		0.13	0.75
19	6	X-253993	PLATFORM REINFORCEMENT KIT ANGLE	52 25/32 in	14.33	85.93
20	6	X-TBW	T-BRACKET WELDMENT		13.60	81.60
21	6	G5802	5/8" x 2" HDG HEX BOLT GR5		0.27	1.62
22	12	G12065	1/2" x 6-1/2" HDG HEX BOLT GR5 FULL THREAD	5 1/2 in	0.41	4.91
23	3	X-AHCP	ANGLE HANDRAIL CORNER PLATE		12.92	38.76
					TOTAL WT. #	2445.81

REV	DESCRIPTION OF REVISIONS	CPD	BY	DATE
B	RELOCATED MOUNT PIPE POSITIONS	4488	JET	5/23/2021
A	CHANGED X-253992 TO X-TBW	4488	CEK	5/20/2018
REV	DESCRIPTION OF REVISIONS	CPD	BY	DATE
REVISION HISTORY				

**TOLERANCE NOTES**  
 TOLERANCES ON DIMENSIONS, UNLESS OTHERWISE NOTED ARE:  
 SAHED, SHEARED AND GAS CUT EDGES (# 0.007")  
 DRILLED AND GAS CUT HOLES (# 0.007") - NO CORING OF HOLES  
 LASER CUT EDGES AND HOLES (# 0.010") - NO CORING OF HOLES  
 BENDS ARE ± 1/2 DEGREE  
 ALL OTHER MACHINING (# 0.0007")  
 ALL OTHER ASSEMBLY (# 0.0007")

**DESCRIPTION**  
 12' 6" LOW PROFILE PLATFORM  
 WITH TWELVE 2-3/8" ANTENNA MOUNTING  
 PIPES, AND SUPPORT RAIL

**valmont**  
 Locations:  
 New York, NY  
 Atlanta, GA  
 Los Angeles, CA  
 Plymouth, IN  
 Dallas, OR  
 Dallas, TX

Engineering Support Team: 1-888-753-7466

CPD NO: 4488  
 DRAWN BY: CEK 7/14/2014  
 ENG. APPROVAL: [Signature]  
 PART NO: RMQP-496-HK  
 CLASS: B1 SUB: 02 DRAWING USAGE: CUSTOMER CHECKED BY: BMC 7/14/2014  
 DWG. NO: RMQP-496-HK

Attachment 1- Antenna Platform for Skenandoah Monopole

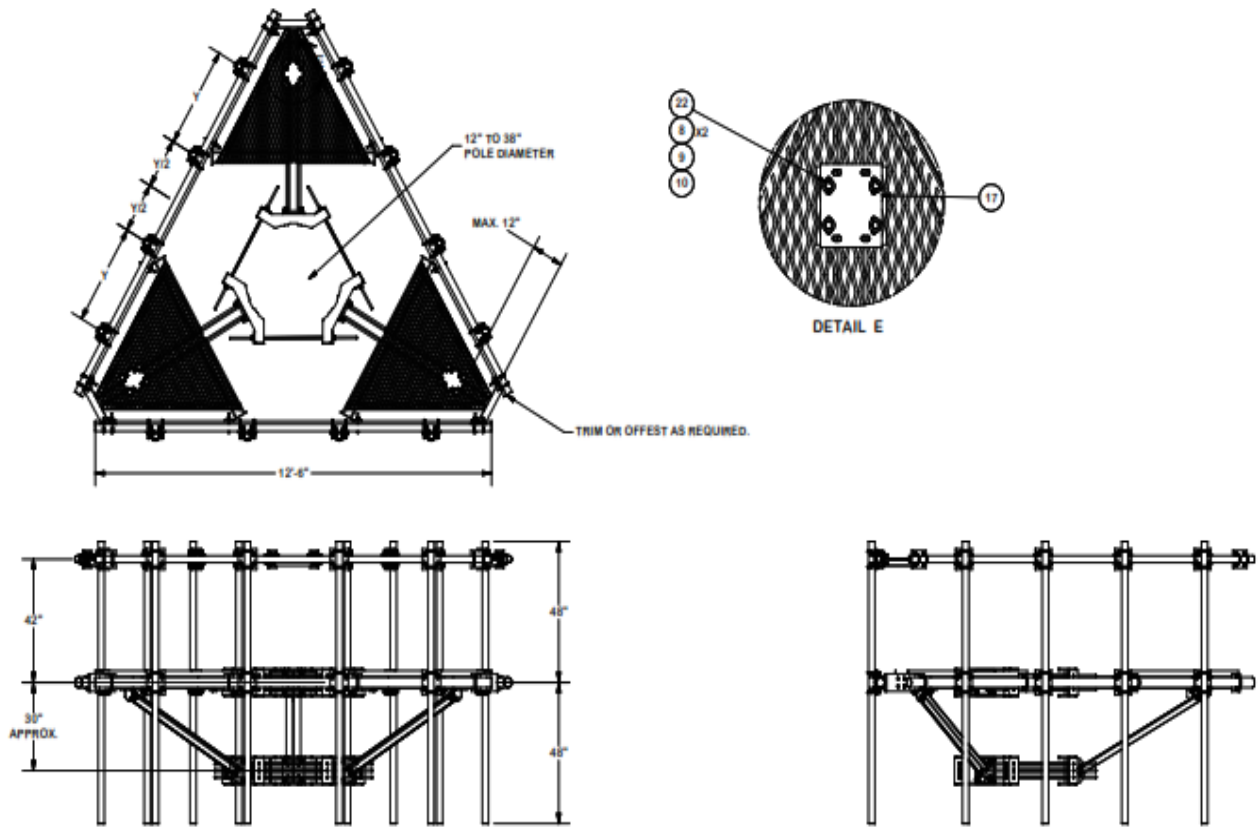

TOLERANCE NOTES				DESCRIPTION		SITE PRO	
TOLERANCES ON DIMENSIONS, UNLESS OTHERWISE NOTED ARE: BAWLED, BEHEARD AND GAS CUT EDGES ( $\pm 0.005$ "*) DRILLED AND GAS CUT HOLES ( $\pm 0.005$ "*) - NO CONING OF HOLES LASER CUT EDGES AND HOLES ( $\pm 0.010$ "*) - NO CONING OF HOLES BENDS ARE $\pm 1/2$ DEGREE ALL OTHER MACHINING ( $\pm 0.005$ "*) ALL OTHER ASSEMBLY ( $\pm 0.005$ "*)				12" LOW PROFILE PLATFORM WITH TWELVE 2-3/8" ANTENNA MOUNTING PIPES, AND SUPPORT RAIL		Locations: New York, NY Atlanta, GA Los Angeles, CA Plymouth, IN Salem, OR Dallas, TX Engineering: Support Team: 1-888-752-7446	
CPD NO.	4488	DRAWN BY	CEK	7/14/2014	ENG. APPROVAL	PART NO.	RMQP-496-HK
CLASS	81	SUB	02	DRAWING USAGE	CUSTOMER	CHECKED BY	BMC
DATE	7/14/2014					DWG. NO.	RMQP-496-HK
REVISION HISTORY REV DESCRIPTION OF REVISIONS CPD BY DATE				PREPARED BY THE DATA AND DIMENSIONS SHOWN ON THIS DRAWING ARE THE PROPERTY OF SITE PRO AND SHALL REMAIN THE PROPERTY OF SITE PRO. ANY USE OR REPRODUCTION WITHOUT THE CONSENT OF SITE PRO IS STRICTLY PROHIBITED.			
B	RELOCATED MOUNT PIPE POSITIONS	4488	JET	5/23/2021			
A	CHANGED X-253992 TO X-TBW	4488	CER	9/20/2018			

Attachment 1- Antenna Platform for Skenandoah Monopole

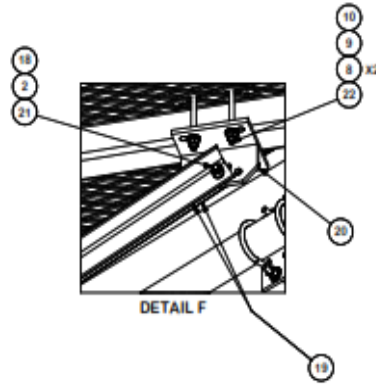
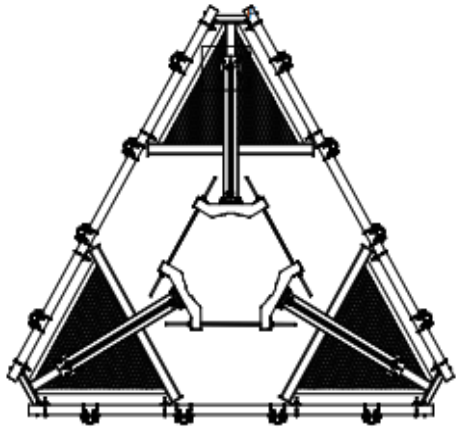
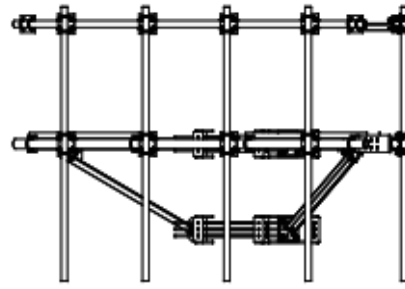
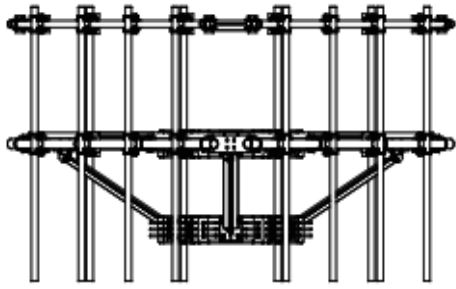

REVISION HISTORY				TOLERANCE NOTES			DESCRIPTION			PART NO.		
B	RELOCATED MOUNT PIPE POSITIONS	4488	JET	5/23/2021	<b>TOLERANCES ON DIMENSIONS, UNLESS OTHERWISE NOTED ARE:            SAWS, SHEARED AND GAS CUT EDGES (± 0.000")            DRILLED AND GAS CUT HOLES (± 0.000") - NO CORING OF HOLES            LASER CUT EDGES AND HOLES (± 0.010") - NO CORING OF HOLES            BENDS ARE ± 1/2 DEGREE            ALL OTHER MACHINING (± 0.000")            ALL OTHER ASSEMBLY (± 0.000")</b>	12" 6" LOW PROFILE PLATFORM WITH TWELVE 2-3/8" ANTENNA MOUNTING PIPES, AND SUPPORT RAIL			RMQP-496-HK			
A	CHANGED X-253892 TO X-TBW	4488	CEK	9/20/2018		CPD NO. 4488	DRAWN BY CEK	7/14/2014	ENG. APPROVAL	RMQP-496-HK		
REV	DESCRIPTION OF REVISIONS	CPD	BY	DATE		CLASS 81	SUB 02	DRAWING USAGE CUSTOMER	CHECKED BY BMC	7/14/2014	ENG. NO. RMQP-496-HK	
REVISION HISTORY					<small>PROPERTY NOTE: THE DATA AND INFORMATION CONTAINED IN THIS DRAWING ARE THE PROPERTY OF VALMET CORPORATION. NO PARTS OF THIS DRAWING OR INFORMATION HEREIN MAY BE REPRODUCED OR TRANSMITTED IN ANY FORM OR BY ANY MEANS, ELECTRONIC OR MECHANICAL, INCLUDING PHOTOCOPYING, RECORDING, OR BY ANY INFORMATION STORAGE AND RETRIEVAL SYSTEM, WITHOUT THE WRITTEN PERMISSION OF VALMET CORPORATION.</small>						<b>Locations:</b> New York, NY Atlanta, GA Los Angeles, CA Plymouth, MN Dallas, TX	

Attachment 1- Antenna Platform for Skenandoah Monopole

## HORIZONTAL WAVEGUIDE BRIDGE

The waveguide bridge shall extend ten-feet away from the monopole base, as shown on the plans, and engineered to provide horizontal support of waveguide and coaxial feedlines. Cabinets will be installed, by others, adjacent to the waveguide bridge.

The waveguide bridge shall be 24 inches wide and shall be suitably attached and supported only to its support pipes independent of the monopole, and shall have sufficient strength to support two 250 pound persons and shall ensure that no damage is sustained by a falling one cubic foot block of ice from the top of the monopole. The ice bridge should be fully supported by a minimum of two pairs of pipe columns.

The horizontal support of the feedlines under the waveguide bridge shall be via a two tier galvanized angle trapeze, with combination 3/4 inch O.D. and 7/16 inch drilled holes for the securement of hanger kits, with each

end supported vertically from the overhead waveguide bridge channel via 3/8 inch galvanized threaded rods. These hanger kit support frames shall be spaced horizontally every 3 feet under the waveguide bridge.

## **TOWER DOCUMENTATION REPORT**

A complete and orderly summary of the stress analysis showing loading considerations, base reactions, allowable stresses and maximum computed forces is required for the monopole. The analysis is to be certified by a registered professional engineer with experience in tower design.

Complete installation drawings are required at the conclusion of the project, complete with as-built corrections reflecting the completed installation.

Before submitting drawings or other data to ONEIDA NATION it shall be the sole responsibility of the Bidder to comprehensively and thoroughly check same for accuracy and full compliance with plans and specifications and proper form, fit and function.

Where a specific material, process, or product is specified, and the Bidder desires to provide an improvement or equal, he shall submit a statement to this effect to ONEIDA NATION.

Monopole manufacturer shall provide the foundation design based on the soils survey and soils report. The foundation design shall be signed by a registered professional engineer.

## **SHELTER (X2)**

A 12-foot by 20-foot shelter shall be provided and installed, including an engineered foundation at two of the three tower locations.

A single 20-foot concrete encased (Ufer) ground electrode shall be provided and installed with the shelter foundation, bent as needed to fit within the perimeter of the footing. The steel electrode must extend above the concrete a minimum of six inches to allow an exothermically welded connection to the ground system. An electrical connection shall be made to the Ufer electrode only as required by the local jurisdiction.

The specified shelter is a CellXion (Sabre), Fibrebond, or Modular Connections concrete aggregate shelter, as specified in the attachments. The shelter shall be complete, including HVAC, electrical & grounding systems, lighting, four equipment racks, cable tray, and other factory-installed accessories, as specified. The shelter must come with the following factory-installed options:

1. 12-foot x 20-foot concrete shelter, with neutral aggregate finish
2. 40-inch level-4 ballistic door with hydraulic closer
3. Service entrance & load center, 200A, 42 position (minimum) with surge arrestor
4. 200A automatic transfer switch
5. Conduit entrance: Two 2" penetrations (sealed for future use)
6. HVAC unit: 24K BTU w/ 10K heating, standard thermostat, and exterior GFCI service receptacle



7. Interior lighting: Six 4-foot fixtures
8. Exterior lighting: One 75-watt (equivalent) fixture
9. Quad receptacles: Two per wall and two on ceiling (one above each row of racks)
10. Alarms: Door entry, high and low temperature, smoke, terminated on wall-mounted terminal block
11. Waveguide entrance: 4" x 8 holes
12. Relay racks: four installed per floor plan
13. Cable ladder: 12-Inch wide, above both rows of racks, per floor plan
14. Ground halo: R56 #4 AWG halo, with insulated standoffs, and with #6AWG along cable tray, with each corner exothermically welded, via pigtailed to exterior ground ring
15. Ground bus: 20" ground bus, insulated, one interior and one external to the waveguide entrance, with the interior tied to the ground halo and the exterior exothermically welded to exterior ground ring.
16. Ventilation fan: 585cfm (min) exhaust fan with thermostat and filtered intake louver
17. Professional Engineered / stamped drawing set
18. State review, inspection, and insignia / seal for State of Wisconsin
19. Freight and offload at job site

ONEIDA NATION will review shop drawings and the shelter engineering packet. The contractor shall submit the shelter engineer's permitting package to ONEIDA NATION for approval prior to shipment of the shelter. Prior to installation, the contractor shall submit the engineering and design package to ONEIDA NATION for approval. The engineering package shall be stamped by a structural or civil engineer, licensed in the State of Wisconsin.

A tribal construction permit will be required. The Tribal inspection department will monitor the project and inspect the foundation work. Additionally, the contractor shall hire a certified testing agency to perform concrete testing, with a minimum of a 7-day and 28 day compressive strength test, in addition to a slump test. The results shall meet the engineering requirements and be submitted to ONEIDA NATION for review and approval.

Installation of the shelter will not require any outdoor conduit, as the power system, including conduit to the shelter will be the responsibility of others. External ground connections to the shelter will also be the responsibility of others.

## **Site Development**

### **Site preparation**

Construction for all three sites will include grubbing, trenching, conduit placement, fencing, and grounding, in addition to the tower and shelter installations described above. Contractor will provide generator installation and startup services at the Northwest and Public Safety sites. The sites will be surveyed and construction stakes

will be placed by others, prior to the start of construction. See Attachment D for additional site preparation details.

Surface finishing within each compound shall include a layer of landscaping fabric (Mirafi HP 270 or approved equal), finished with 6-inches of 1-1/2" minus rock, compacted to support light vehicle traffic.

The Public Safety Tower site shall require the construction of a rocked driveway from the right-of-way on County Road E, using the existing driveway approach at the road, extending approximately 400 feet to the site and including a 25-foot by 80-foot parking / turn-around area across the front of the site. The Contractor shall be responsible for ensuring that the existing driveway skirt meets the requirements of the local jurisdiction. The road-bed for the driveway and parking area shall use the materials and follow the profile provided in Attachment C. If damaged during construction, the driveway will be restored to its original condition at the end of the project.

The Northwest tower will require a small area for a vehicle approach between the existing driveway and the vehicle gate. This area will be an extension of the geotextile fabric, and compacted rock used within the compound.

The Skenandoah site shall require a concrete driveway. The existing sidewalk and curb must be removed and replaced with a sloped skirt section that follows the local jurisdiction's requirements for a typical residential driveway. The curb line must be no higher than 2-inches above the existing pavement. To minimize the chance of damage, the Contractor may choose to delay concrete placement until later in the project, after crane and other heavy vehicle traffic is completed, when there may be more down time for the concrete to properly cure. After construction is complete, any damage to the parking lot, curb, sidewalk, driveway, and lawn must be repaired.

An electrical service entrance shall be installed for the Public Safety site and the Northwest site, including a vault within the compound, a vault at the public right of way, connected by two 3" conduit. One 2" conduit will be placed from the compound vault to the shelter's meter base. The vaults shall meet the local utility's requirements and the contractor shall be responsible for coordinating with the utility for installation of the service. The meter base shall meet all requirements set by the local utility and jurisdiction for specifications and service disconnect requirements. The location for the electrical service and meter base is approximately shown on the site plans. Those two sites will also require a hand hole within the compound, and a handhole near the right of way, connected by a 2" conduit, for a future fiber installation. The fiber conduit shall be placed at a minimum depth of 24 inches and the separation between telecom and power shall be a minimum of 12 inches. All conduit will be installed using long sweeps (not to exceed 180 degrees or 300-feet between vaults or handholes), and mule tape, to facilitate cable installations by others. All conduit shall be sized and placed at a depth that meets all local codes and conventions for their intended use.

The Skenandoah site will receive electrical power from the adjacent office. This project will install two 2" conduits from the building to the compound, to locations determined by the Tribal representative. One conduit will support a future branch circuit (electrical installation by others). The other conduit shall support fiber optic cable (cable installed by others). Both conduits shall include mule tape. The power conduit shall include a junction box on the exterior wall of the building, located as directed, and will terminate in a 3' x 3' vault in the compound. The telecom conduit shall include a junction box on the interior wall of the building, located as directed, and will terminate on a NEMA 4x junction box, mounted to an ice bridge support pipe, as shown on the site drawings. Both conduits shall be placed at a minimum depth of 36 inches and will be separated by 12" horizontally. A portion of the trench shall be left exposed, to allow for additional telecom and power conduits

to be placed by others at a later date. The trench must be adequate for more conduits to be added, for the generator installation later in the season.

## **Fencing and grounding**

Fencing and grounding shall be provided at all sites under this scope of work. Site grounding shall include connections to the electrical service entrance, tower, shelter, generator, and fence components.

Construction of the fence must be coordinated with other site work, specifically the grounding. The bidder must locate existing ground conductors before commencing work. Bidder will also dig a trench for new conductors, as indicated above. If bedrock is encountered at a depth less than 12-inches, a reasonable effort with rock hammer or concrete saw shall be used to set the conductor at a depth of 12-inches. If conditions are discovered that would require more than a reasonable amount of effort with a rock hammer or saw, allowance may be given for a reduced depth. However, any adjustment shall be subject to review and approval by the Tribal representative. The trench depth shall be up to a maximum depth of 12 inches, depending on the depth of soil before hitting bedrock.

Fencing shall meet the following specifications:

1. 7-foot tall cyclone fence enclosing the site dimensions reflected on each site plan, shall be constructed using 2-inch, 6 gauge galvanized fence fabric.
2. In-line posts to be 2-1/2 inch schedule 40 galvanized pipe, set 24-inches deep and in an 8-inch diameter concrete footing. Post spacing shall be ten feet or less.
3. Corner posts shall be 3-1/2 inch schedule 40 galvanized pipe, set 36-inches deep in a concrete footing, 10 inches in diameter. Diagonal supports shall anchor to the adjacent post and be adjustable.
4. Posts for gates shall meet the same requirements as corner posts.
5. 3 strands of barbed wire will be installed on top of the fence angled outwards in an 18 inch spread adding an additional 1 foot, for a total height of 8-feet. The entire fence line shall include barbed wire, with suitable barbed wired transitions for gates, as needed.
6. The top rail shall be 1-5/8 inch OD schedule 40 galvanized pipe.
7. Gates shall include one 4-foot wide personnel gate and one 16-foot wide (2 eight foot panels) double-swing vehicle gate. Vehicle gate posts shall be 3-1/2 inch schedule 40 galvanized pipe.
8. All gates shall be lockable using a heavy duty locking mechanism. Latch assembly for vehicle gates shall engage into a center stop set in a concrete footing large enough to secure the gate adequately.

In reference to the site & grounding plans in Attachment C, this project will provide all ground electrodes and conductors. Location of existing underground facilities is the responsibility of the Contractor. Therefore, care must be used to avoid damage to existing conductors. Ground connections are included for a generator and LP tank, where shown.

Grounding shall meet the following specifications:

1. All grounding conductors shall be No. 2 AWG stranded tinned copper.
2. Conductor to conductor connections shall be exothermically welded, as well as connections to fence posts and ground rods.
3. Buried conductors shall be placed 12” below grade, as limited by bedrock.
4. Ground rods (5/8” x 10”) shall be driven full depth to below grade, or to refusal. Rods that cannot be fully driven, shall be supplemented with additional rods, subject to approval of the Tribal representative.

In reference to the site plans in Attachment D, bollards shall be installed, where indicated, to protect the generator, propane tank, and other equipment. Each bollard shall consist of a 4-inch galvanized schedule 80 pipe, set to a 3-foot depth, in an 18-inch diameter concrete footing. The bollard shall extend 40-inches above ground, and be filled with concrete, rounded at the top. All bollards shall be primed, then painted in bright yellow enamel.

## **Backup Generator**

Backup Generators shall be provided for the Public Safety and Northwest tower sites. The contractor shall provide and install a 36KW / 45KVA propane generator, 500 Gallon propane tank, a service disconnect, automatic transfer switch, and all necessary wiring, conduit, and piping necessary to place the system into service at each location. The generator must be factory-equipped with generator-mounted overcurrent protection. The Contractor shall be responsible for obtaining start-up services from a factory-authorized service company.

The generator system shall be rated and approved for non-prime-power (standby) use. Contract shall include the purchase, installation, wiring, parts, fuel source hookup and testing. Installation services shall provide all wiring, conduit, system components, and startup services necessary to place the generator into service. The fuel tank must be filled before final acceptance of the system.

The generator shall be a single phase, 240/120 volt system with generator-mounted overload protection. It shall include a 120V block heater and trickle charger, and be equipped with vibration isolation. Oil drain shall be equipped with shutoff valve and shall be plumbed to the generator set frame where it shall be capped with an NPT pipe fitting and be easily accessible for maintenance.

The piping for the propane tank shall be sized per generator manufacturer’s recommendations and per local code and be buried at a depth of 18-inches. Exposed piping must be black steel, but buried pipe may be polyethylene designed for the purpose.

One 2-inch and one 1-1/2” conduit shall be installed from the generator pad to an automatic transfer switch, to be installed in the shelter, adjacent to the service entrance. The three-pole automatic transfer switch shall be configured to switch the neutral. It shall be configured for the neutral to be simultaneously switched with the ungrounded conductors.

The system must have digital controls, equipped with TCP/IP SNMP capability for status monitoring and control. The generator controls must also include an automatic exercise function that can be set for weekly or monthly testing and include configurable warm-up and cool down features. The system must be NFPA-110 compliant and be UL-2200 rated.

The generator shall be permanently attached to a concrete footing. See attachment D for concrete and compacted rock requirements. The propane tank may be mounted to two curb-style concrete beams, which in turn shall be placed on a six-inch bed of  $\frac{3}{4}$  minus compacted rock, extending six-inches beyond the horizontal dimensions of the beams.

The automatic transfer switch shall be mounted in the shelter, in a NEMA 3R cabinet, rated at 200A minimum, microprocessor-controlled, UL listed, and meet NFPA 110 for standby power systems. ATS shall be a 3-pole design with a fully-rated un-switched neutral. Mechanism shall be double-throw and mechanically interlocked.

The manufacturer's and dealer's warranty shall be for a minimum period of two (2) years from date of initial start-up of the system and shall cover repair parts, labor, reasonable travel expense necessary for repairs at the job site, and expendables (lubricating oil, filters, antifreeze, and other service items made unusable by the defect) used during the course of repair. Applicable deductible costs shall be specified in the manufacturer's warranty. Running hours may be a limiting factor for the system warranty by either the manufacturer or servicing dealer. The bid must include a detailed written warranty, including the hours of operation covered under the warranty, and any terms and conditions

## **CODES, STANDARDS AND SPECIFICATIONS**

Issues of the following documents, in effect at this time of solicitation for bids, form a part of this specification. In the event of a conflict between this specification and the codes, standards and specifications below, the most stringent and/or current requirement shall govern.

American Institute of Steel Construction (AISC): Manual of Steel Construction.

Electronics Industries Association (EIA) Standard TIA-222-H: Structural Standards for Antenna Towers and Antenna Supporting Structures

American Welding Society (AWS): Structural Welding Code

American Institute of Steel Construction (AISC): Specification for Structural Joints using ASTM A325 or A490 Bolts

American Concrete Institute ACI 318: Building Code Requirement for Reinforced Concrete

Concrete Reinforcing Steel Institute (CRSI) Manual of Standard Practice.

American Society for Testing and Materials (ASTM)

National Electric Code (NEC): Tower Lighting Kits.

FAA Advisory Circular #AC 70/7460: Obstruction Marking and Lighting.

FCC: Federal Communications Commission Rules and Regulations

# Attachment C: Site Locations, Site Plans & Site Description

## Lattice Tower A -“Public Safety Tower”

The planned tower site is on County Rd E, De Pere, WI 54115 (To the west of County Rd E, across from Onida One-Stop, north of the intersection with County Rd Ee) with the following coordinates: 44° 26' 43.1" N, 88° 13' 39.6" W

The tower ground level is: 737 feet AMSL (224.6 meters) and the tower height will be: 100 feet (30.48 meters) AGL (110 feet (33.528 meters) with appurtenances).

This project will include the development of a 80 ft by 80 ft tower compound, security fencing, grounding system, communications shelter, generator set (fuel tank, generator, transfer switch), tower foundation and tower erection.

Additionally, an approximately 400 ft. gravel access road will need to be improved to the tower site. See gravel cross-section profile following the grounding diagram.

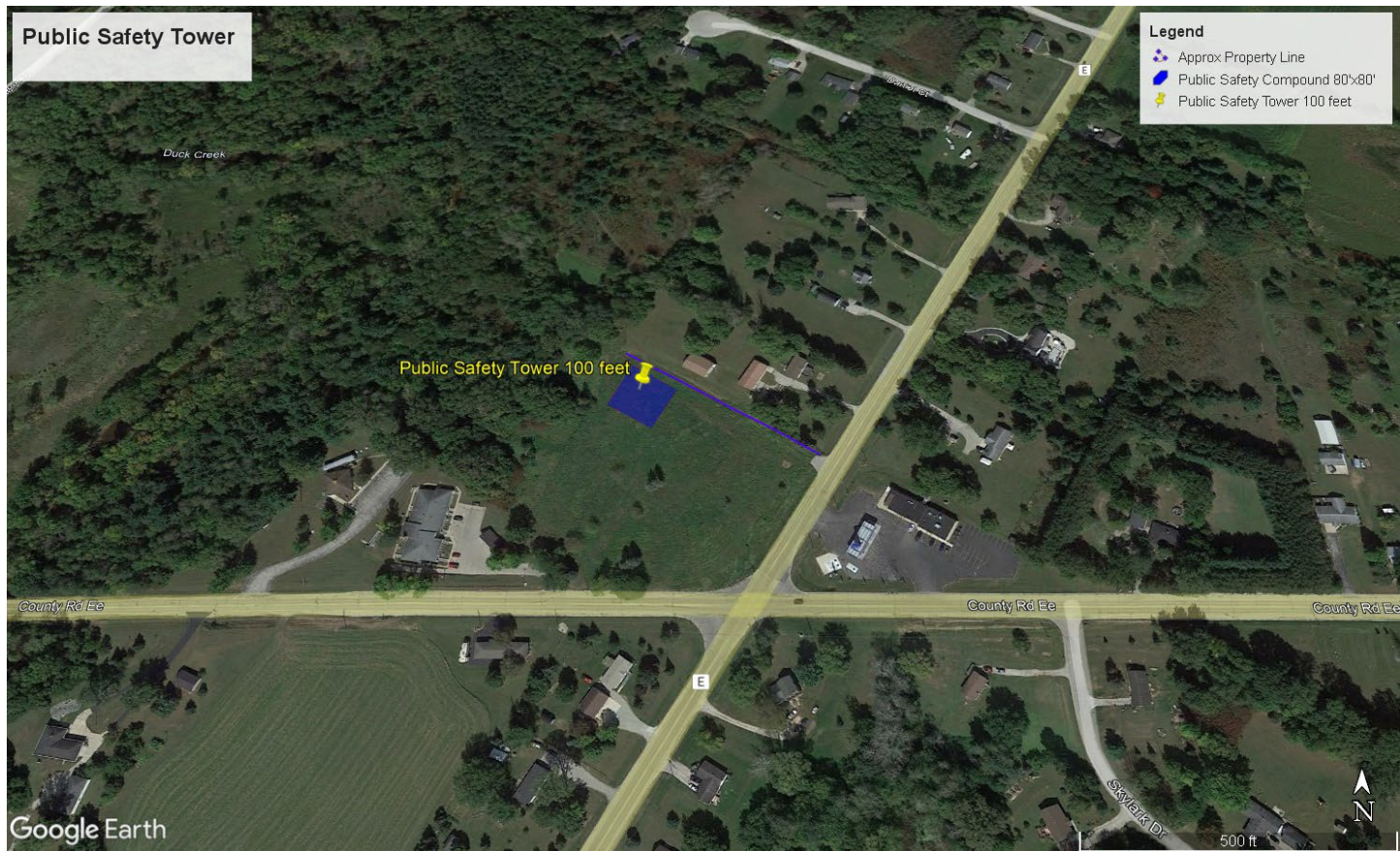

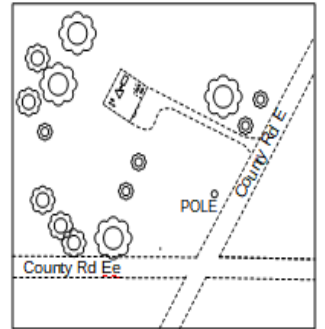
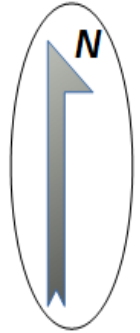
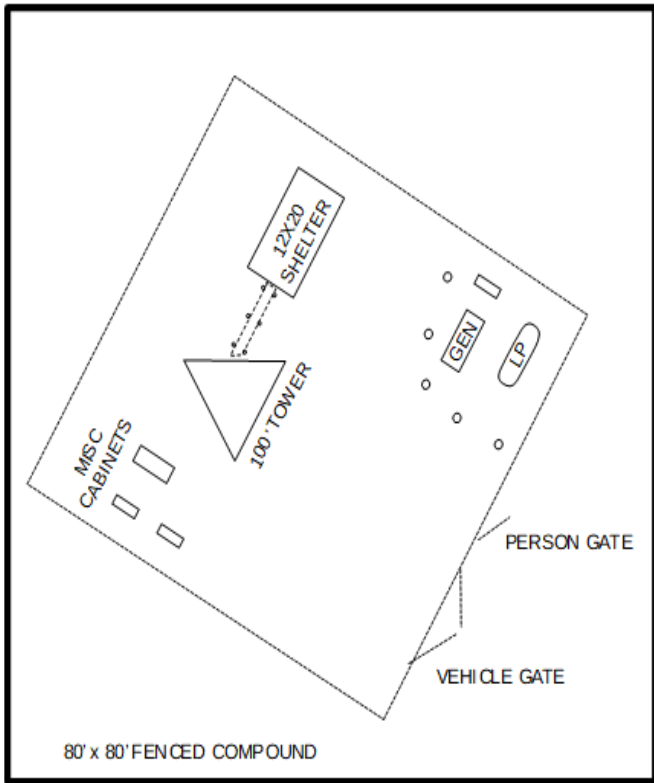

VICINITY MAP (NTS)

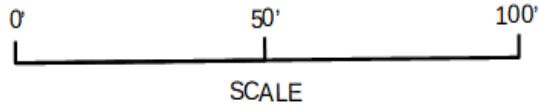

ONEIDA TOWER PROJECT  
 GENERAL SITE PLAN  
 Public Safety Site  
 6/19/2023





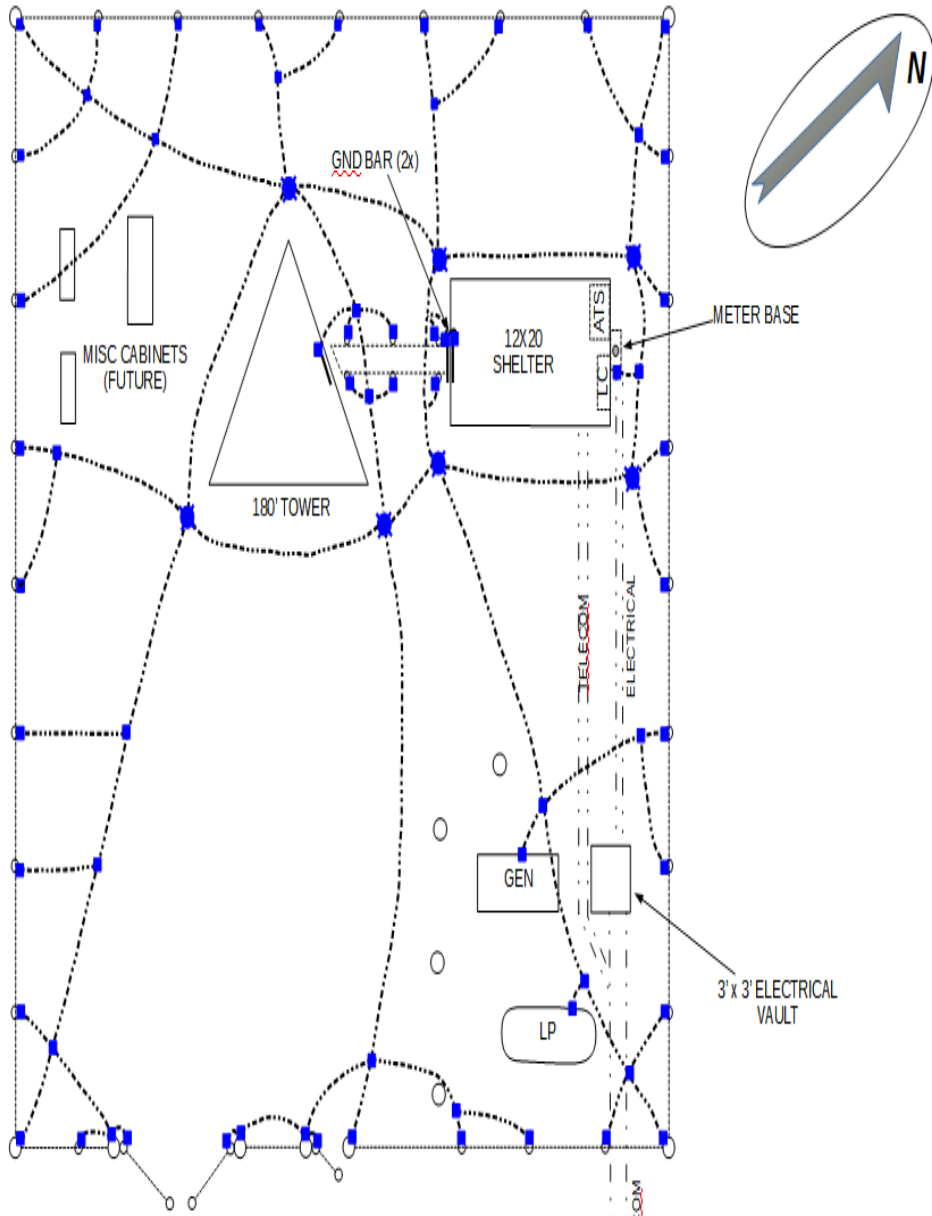

80' x 80' FENCED COMPOUND



**SYMBOL KEY**

-  5/8" x 10' GROUND ROD (6x)
-  EXOTHERMIC WELD, VARIOUS
-  No. 2 AWG STRANDED TINNED COPPER

ONEIDA TOWER PROJECT  
GROUNDING PLAN  
Public Safety Site  
3/18/2023



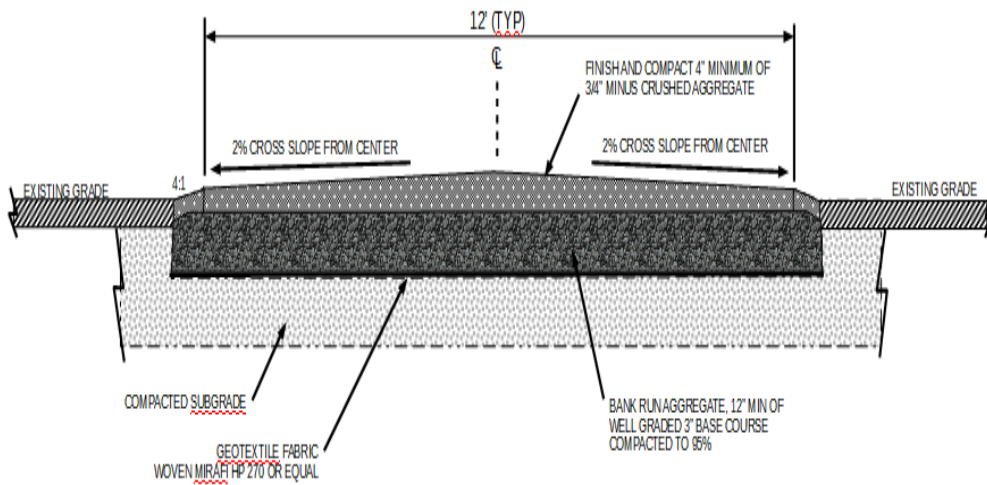

### GRAVEL DRIVE CROSS SECTION

**NOTES:**

1. REMOVE ALL TOPSOIL AND ORGANIC MATERIAL, WET OR POOR SOILS. IF POOR SOILS ARE ENCOUNTERED AT A DEPTH GREATER THAN 15 INCHES, TRIBAL REPRESENTATIVE MAY BE CONSULTED FOR GUIDANCE.
2. WIDTH OF BASE COURSE TO BE 18" BEYOND EDGES OF FINAL FINISHED SURFACE
3. CONTRACTOR SHALL BE RESPONSIBLE FOR REPAIR OR RESTORATION OF DRIVE FOLLOWING CONSTRUCTION ACTIVITY AND MUST BE IN AS-NEW CONDITION UPON COMPLETION OF THE WORK.

ONEIDA TOWER PROJECT  
 DRIVEWAY CROSS SECTION  
 Public Safety Site  
 11/4/2023



## **Lattice Tower B -“NW Tower”**

The planned tower site is located at N7890 Cooper Rd, Oneida, WI 54155 with the following coordinates: 44° 31' 24.5" N, 88° 13' 50.2" W

The tower ground level is: 768 feet AMSL (234.1 meters) and the tower height will be 180 feet (54.9 meters) AGL (190 feet (57.9 meters) with appurtenances)

This project will include the development of a 80 ft by 80 ft tower compound, security fencing, grounding system, communications shelter, generator set (fuel tank, generator, transfer switch), tower foundation and tower erection.

Additionally, an approximately 20 ft. gravel area between the vehicle gate and existing driveway will be required, using the same base and finish course as is used for the interior of the compound.



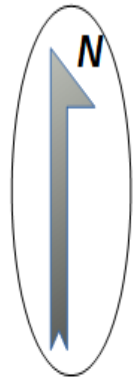

80' x 80' FENCED COMPOUND

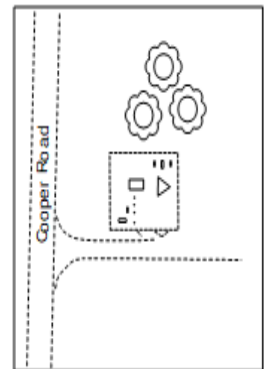
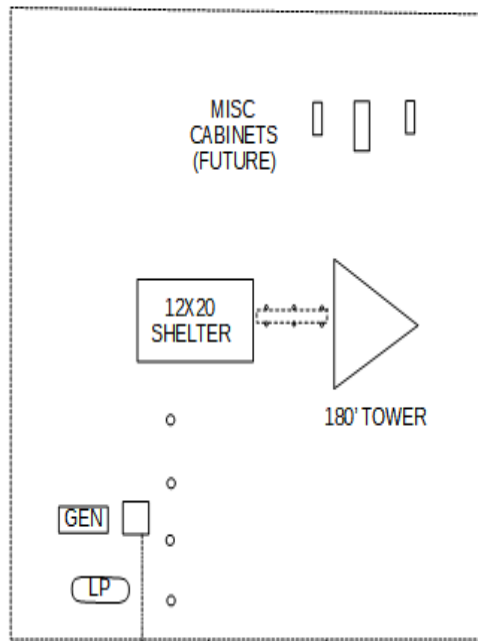

VICINITY MAP (NTS)

PERSON GATE

VEHICLE GATE

(40' to ROW) ←

EXISTING DRIVEWAY

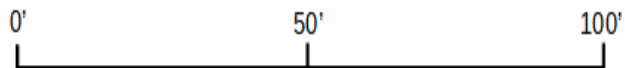

SCALE



ONEIDA TOWER PROJECT  
GENERAL SITE PLAN  
NW Site  
6/16/2023

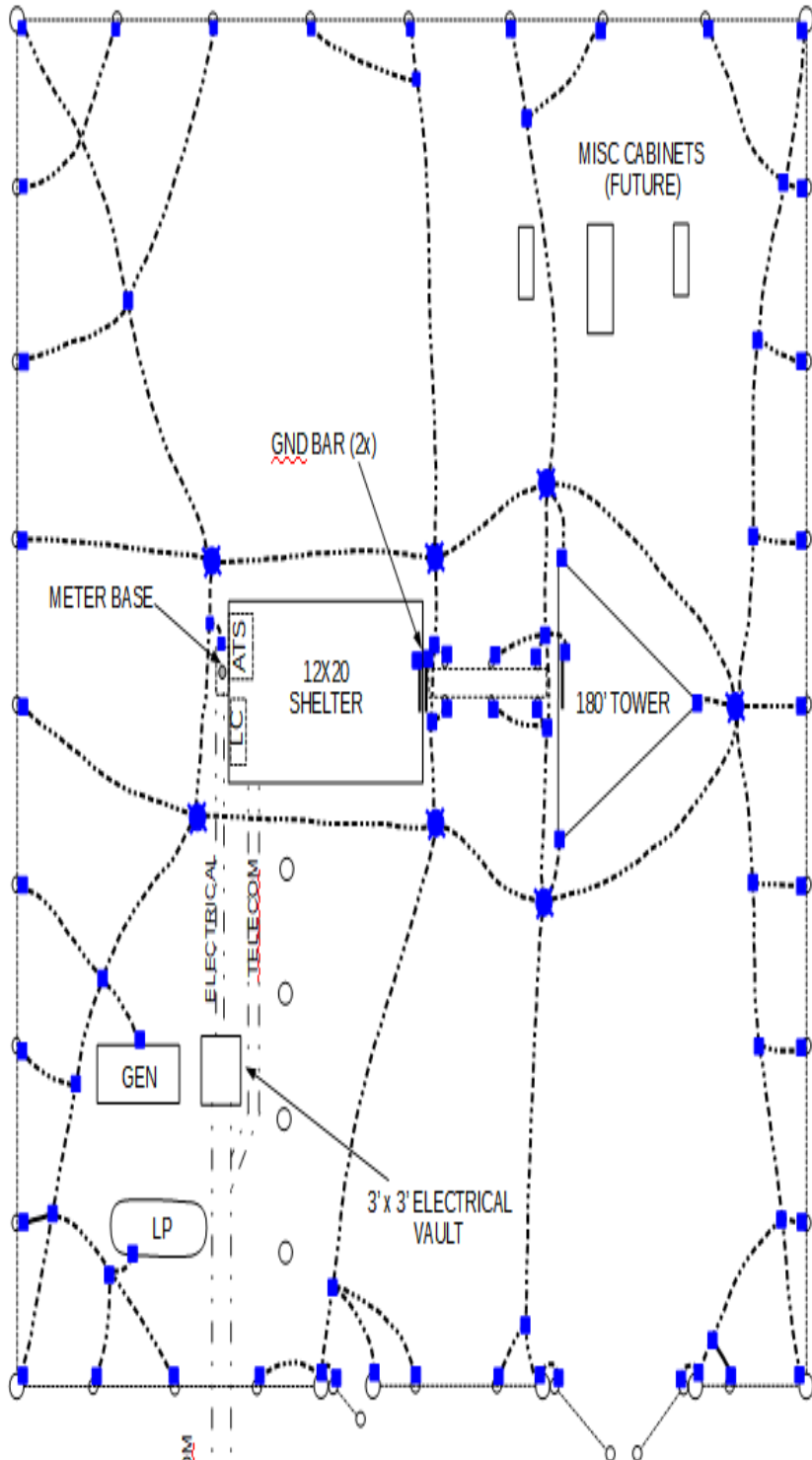
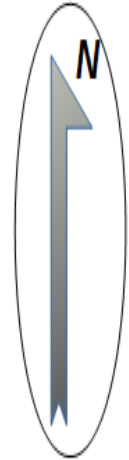

80' x 80' FENCED COMPOUND



**SYMBOL KEY**

-  5/8" x 10' GROUND ROD (6x)
-  EXOTHERMIC WELD, VARIOUS
-  No. 2 AWG STRANDED TINNED COPPER

ONEIDA TOWER PROJECT  
GROUNDING PLAN  
NW Site  
3/18/2023



## Monopole Tower C-“Skenandoah Tower”

The planned tower site is located at 909 Packerland Dr, Green Bay, WI 54303 adjacent to the Skenandoah Complex with the following coordinates: 44° 31' 35.8" N, 88° 5' 50.4" W

The tower ground level is: 691 feet AMSL (210.6 meters) and the tower height will be 150 feet (45.7 meters) AGL (160 feet (48.8 meters) with appurtenances)

This project will include the development of a 25 ft by 40 ft tower compound, security fencing, grounding system, communications cabinets, tower foundation and tower erection. Commercial and emergency power will be provided by the Skenandoah Complex.

Additionally, an approximately 60 ft. concrete driveway will be constructed between the parking lot and the vehicle gate of the tower site. See concrete drive cross-section profile following the grounding diagram.



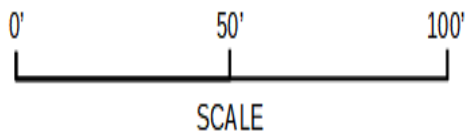
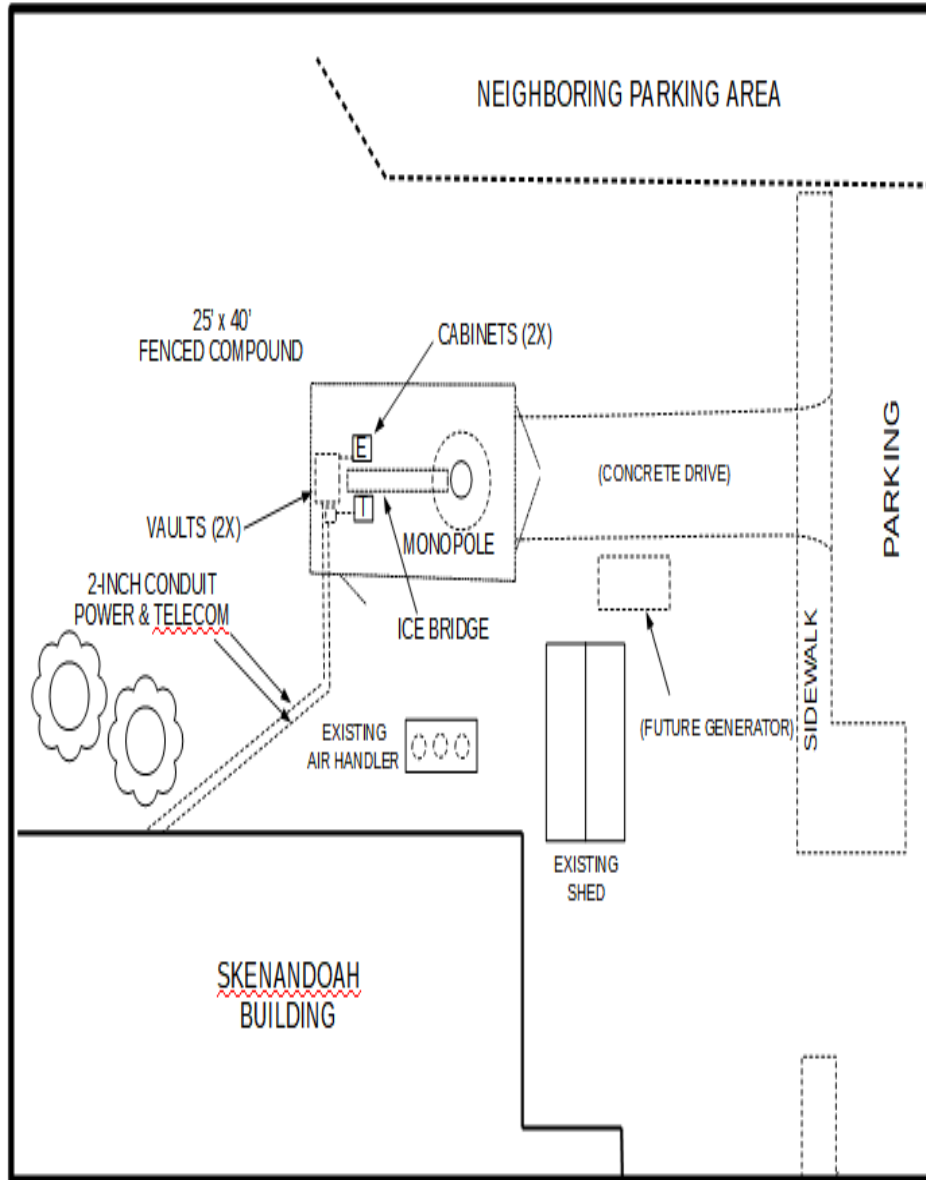
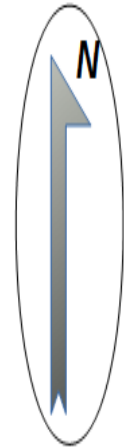





ONEIDA TOWER PROJECT  
GENERAL SITE PLAN  
Skenandoah Site  
11/4/2023

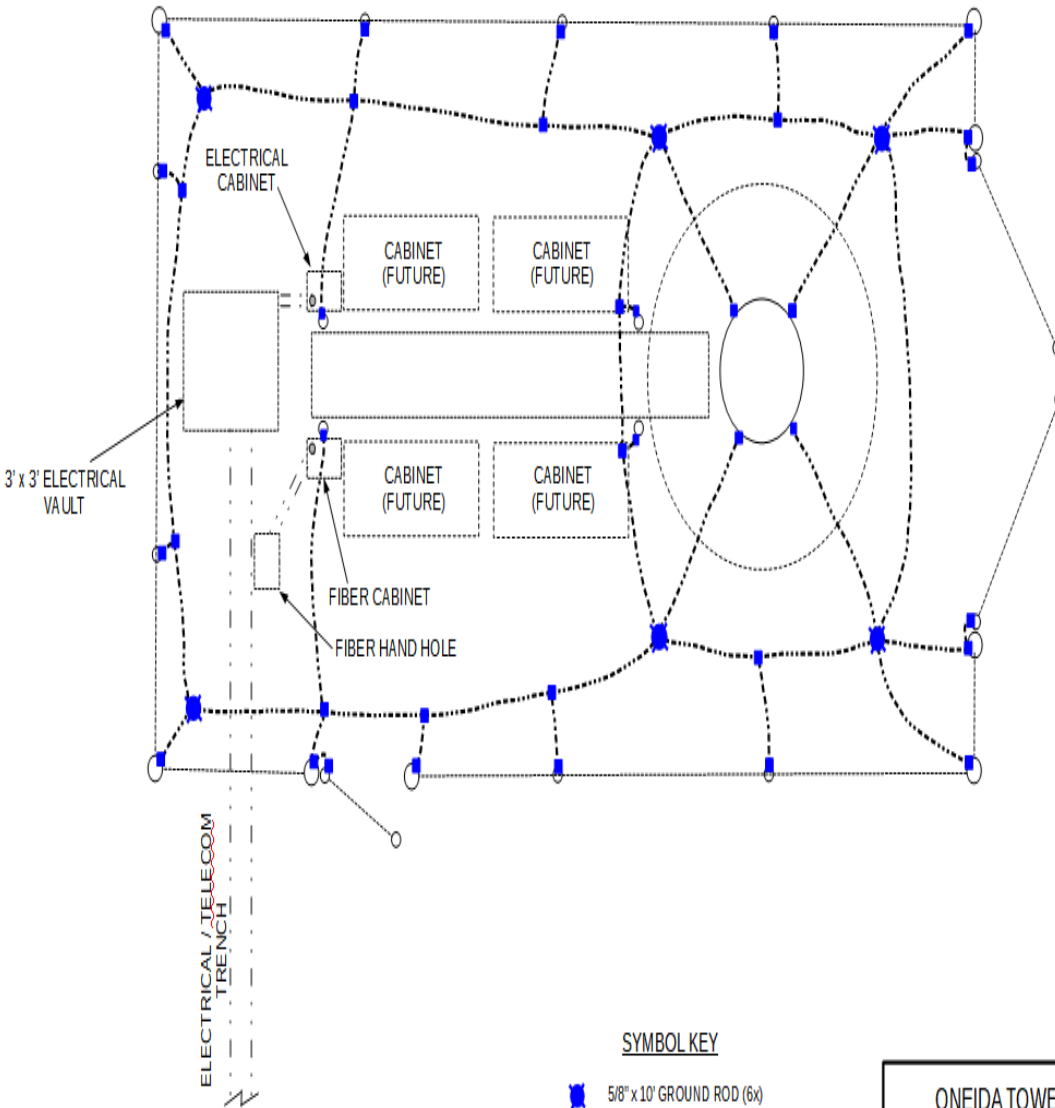
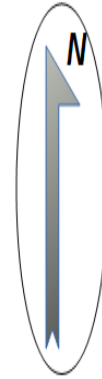

25' x 40'  
FENCED COMPOUND



**SYMBOL KEY**

-  5/8" x 10' GROUND ROD (6x)
-  EXOTHERMIC WELD, VARIOUS
-  No. 2 AWG STRANDED TINNED COPPER

ONEIDA TOWER PROJECT  
GROUNDING PLAN  
Skenandoah Site  
3/16/2023



## CONCRETE & REINFORCING STEEL

### MATERIAL PROPERTIES (U.N.O.)

SPECIFIED COMPRESSIVE STRENGTH OF CONCRETE:

$f_c = 4000$  PSI

SPECIFIED YIELD STRENGTH OF CONCRETE REINFORCEMENT:

$f_y = 60$  KSI (A615 GR 60)

1. ALL BAR LAPS SHALL CONFORM TO ACI 318 CLASS "B" SPLICE CRITERIA. USE TOP BAR LAP LENGTHS FOR TOP BARS IN SLABS AND BEAMS OVER 14" DEEP.

MINIMUM BAR LAPS AS FOLLOWS U.N.O.:

#3:1'-4" #4:1'-4" #5:1'-10" #6:2'-7" #7:4'-2"  
#8:5'-2" #9:8'-4" #10:7'-8" #11:9'-0"

FOR EPOXY COATED BARS, PROVIDE 1.5 TIMES THE INDICATED LAP LENGTH,  
FOR TOP BARS PROVIDE 1.3 TIMES THE INDICATED LAP LENGTH.

2. LAP LENGTH SHALL BE SPECIFICALLY NOTED ON SHOP DRAWINGS WHERE MORE THAN ONE BAR MAKES UP A CONTINUOUS STRING.
3. REINFORCING SHALL BE DETAILED IN ACCORDANCE WITH ACI 315.
4. ALL REINFORCEMENT BARS SHALL BE FABRICATED IN ACCORDANCE WITH THE LATEST CRSI MANUAL OF STANDARD PRACTICE AND SHALL BE CLEAN AND FREE OF GREASE AND SCALING RUST.
5. PROVIDE HOT/COLD WEATHER PROCEDURES AND PROTECTION IN ACCORDANCE WITH ACI RECOMMENDATIONS AND PROJECT SPECIFICATIONS.
6. CONCRETE REINFORCEMENT PROTECTION/CLEAR COVER, U.N.O.:  
FOOTINGS: ALL SIDES 3"  
PIERS: ALL SIDES 3"
7. EXTEND ALL PIER STEEL TO PROVIDE STD. HOOK UNDER FOOTING REINFORCEMENT, UNLESS NOTED OTHERWISE.
8. ALL CONCRETE SHALL BE NORMAL WEIGHT (145 PCF) UNLESS NOTED OTHERWISE. ALL CONCRETE SHALL BE COMPOSED OF PORTLAND CEMENT, TYPE III, IN CONFORMANCE WITH ASTM C 150, FINE AND COARSE AGGREGATE IN CONFORMANCE WITH ASTM C 33, AND WATER IN CONFORMANCE WITH ASTM C 94. EXPOSED EXTERIOR CONCRETE SHALL BE AIR ENTRAINED WITH 6% AIR CONTENT. CONCRETE SHALL HAVE A MEASURED SLUMP OF 4" (CONTRACTOR SHALL PERFORM SLUMP TESTS). IF AN ALTERNATIVE MIX DESIGN IS DESIRED, MIX DESIGN SHALL BE SUBMITTED TO ENGINEER FOR APPROVAL.
9. ALL CONCRETE SHALL BE CONSOLIDATED BY MECHANICAL VIBRATION, SPADING OR RODDING TO ENSURE THAT CONCRETE IS THOROUGHLY AND UNIFORMLY DISTRIBUTED WITHIN FORMWORK AND AROUND REINFORCEMENT AND EMBEDDED ITEMS.
10. ALL FORMED CONCRETE SURFACES EXPOSED TO VIEW SHALL HAVE A SURFACE FINISH SF-2,0 IN ACCORDANCE WITH ACI 301.
11. ALL CONCRETE MIXING, TRANSPORTING, PLACING AND CURING SHALL CONFORM WITH THE LOCAL BUILDING CODE REQUIREMENTS AND THOSE OF THE FOLLOWING STANDARDS (LATEST EDITION):  
"ACI 318, BUILDING CODE REQUIREMENTS FOR REINFORCED CONC."  
"ACI 315, DETAILS AND DETAILING OF CONCRETE REINFORCEMENT"  
"ACI 301, SPECIFICATIONS FOR STRUCTURAL CONCRETE FOR BLDGS."  
"ACI 307, RECOMMENDED PRACTICE FOR CONCRETE FORM WORK"
12. ALUMINUM CONDUIT IS NOT PERMITTED TO BE EMBEDDED IN CONCRETE.
13. ALL DOWELS INTO EXISTING CONCRETE OR SOLID MASONRY TO BE EPOXY ANCHORED WITH HILTI HITHY200 ADHESIVE OR APPROVED EQUIVALENT, (UNLESS NOTED OTHERWISE)
14. UNLESS NOTED OTHERWISE, ANY EXISTING CONCRETE SURFACE IS TO BE CLEANED AND INTENTIONALLY ROUGHED TO A 1/4" AMPLITUDE AND WETTED PRIOR TO FRESH CONCRETE BEING POURED AGAINST SURFACE.

# Attachment D: Indian Preference Law & Indian Preference Vendors

## Document 00 73 35 – INDIAN PREFERENCE LAW

### 1. GENERAL

#### 1.1. REQUIREMENTS

- A. The Contractor is contractually obligated to abide by the Oneida Code of Laws, Title 5. Business - Chapter 502 - Indian Preference in Contracting (aka: Oneida Indian Preference Law).
- B. Per Article 502.9 of the law, the Contractor shall execute a compliance agreement with the Indian Preference Office.
- C. The Oneida Indian Preference Law and Compliance Agreement documents are included below.

END OF 00 73 35 – INDIAN PREFERENCE LAW

ONEIDA INDIAN PREFERENCE LAW and COMPLIANCE AGREEMENT DOCUMENTS FOLLOW

**Title 5. Business - Chapter 502**  
Yukwat^nhas Ukwehu=w# Kayanl^hsla  
Laws concerning the hiring of the Oneida People  
**INDIAN PREFERENCE IN CONTRACTING**

502.1. Purpose and Policy  
502.2. Adoption, Amendment, Conflicts  
502.3. Definitions  
502.4. Jurisdiction  
502.5. Certification of Entities  
502.6. Application of Indian Preference to Contracts  
502.7. Compliance Agreements  
502.8. Skills Bank and Qualified Trades Workers  
502.9. Investigations and Enforcement

---

## **502.1. Purpose and Policy**

502.1-1. *Purpose.* The purpose of this law is to establish an Indian Preference Office and increase economic benefits for the Nation and members of the Nation by providing for the maximum utilization of Indian workers and businesses on projects of the Nation which occur on or near the Reservation.

502.1-2. *Policy.* It is the policy of the Nation to ensure that Indian preference provisions are applied fairly in all situations and in such a way that reflects the intent of this law; and to undertake reasonable efforts to ensure that all entities that enter into contracts with or on behalf of the Nation utilize the labor force of Indian workers and businesses by applying Indian preference in all aspects of fulfilling that contract, including but not limited to: hiring, training, business opportunities, labor and/or professional services, and the supply of materials.

## **502.2. Adoption, Amendment, Conflicts**

502.2-1. This law is adopted by the Oneida Business Committee by Resolution BC-03-27-13-B and amended by resolution BC-04-08-20-I.

502.2-2. This law may be amended or repealed by the Oneida Business Committee and/or General Tribal Council pursuant to the procedures set out in the Legislative Procedures Act. 502.2-3. Should a provision of this law or the application thereof to any person or circumstances be held as invalid, such invalidity shall not affect other provisions of this law which are considered to have legal force without the invalid portions.

502.2-4. In the event of a conflict between a provision of this law and a provision of another law, the provisions of this law shall control. However, this law specifically supersedes the following:

- (a) BC-04-03-96-A - Indian Preference Policy Rider I;
- (b) BC-05-22-96-A - Technical Amendments to Rider I Policy;
- (c) BC-06-10-98-D - Amendment to Resolution 5-22-96-A;
- (d) BC-07-29-98-B - Indian Preference Law;
- (e) BC-03-27-02-A - Sections 9-14 of the Indian Preference Law; and
- (f) BC-03-26-03-A - Amendment to Indian Preference Law Addendum.

502.2-5. This law is adopted under authority of the Constitution of the Oneida Nation.

## **502.3. Definitions**

502.3-1. This section shall govern the definitions of words and phrases used within this law. All words not defined herein shall be used in their ordinary and everyday sense.

- (a) “Agent” means one who acts relative to a fiduciary relationship to another; a person authorized to negotiate and/or transact business on behalf of an entity.
- (b) “Bid” means an offer to execute a specified job or jobs within a prescribed time and not exceeding a proposed amount, and includes both offers that become legally binding upon acceptance, and nonbinding or informal quotes.
- (c) “Bid shopping” means the practice of divulging a contractor’s or subcontractor’s bid to other prospective bidders before the award of a contract, in order to secure a lower bid. (d) “Broker” means an intermediary; an independent contractor employed to negotiate business between a buyer and seller for compensation.
- (e) “Business day” means Monday through Friday from 8:00 a.m. to 4:30 p.m., excluding holidays recognized by the Nation.
- (f) “Certification” means verification by the Indian Preference Office that an entity meets all the requirements necessary to qualify for Indian preference in accordance with this law.
- (g) “Certified entity” means an entity that has received certification as an Indian-owned business from the Indian Preference Office.
- (h) “Compliance agreement” means a binding agreement, negotiated between the Indian Preference Office and a contractor identifying specific Indian preference-related requirements for a project.
- (i) “Construction contract” means any contract issued to build, repair, or remodel structures, and includes subcontracts and other construction agreements.
- (j) “Contractor” means one who enters into a contract.
- (k) “Core work crew” means the minimum amount of the contractor’s key employees, who perform a critical function such that an employer would risk likely financial damage or loss if that task were assigned to a person unfamiliar with and/or untrained in the employer’s procedures and routines, that are essential to start up and continue work on a project.
- (l) “Employee” means any person that performs services and/or labor for an employer in exchange for compensation.
- (m) “Employer” means any entity, except the Nation, that controls and directs an employee under an express or implied contract of employment and is obligated to pay salary or wages in compensation.
- (n) “Enterprise” means any internal operation owned and operated by the Nation that generates revenues through its core business functions, including but not limited to, Oneida Gaming, Oneida Retail, and Oneida Printing.
- (o) “Entity” means any person, sole proprietor, partnership, corporation, franchise, governmental body, or any other natural or artificial person or organization. The term is intended to be as broad and encompassing as possible to ensure this law covers all employment and contract activities within the jurisdiction of the Nation.
- (p) “Entities of the Nation” means all programs, departments, boards, committees, commissions and similar business units of the Nation, but shall not mean Tribal corporations.
- (q) “Front” means a business entity that is strategically structured, financed, operated or staffed such as to unfairly take advantage of Indian preference as granted under this law.
- (r) “Indian” means an enrolled member of any federally-recognized Indian tribe. (s) “Indian-owned business” means an entity which is majority owned and managed by an Indian.
- (t) “Indian preference” means preference for Indians, regardless of tribal affiliation, in all aspects of employment and contracting.
- (u) “Internal service” means any service provided for free or at cost for the Nation and includes but is not limited to such services as certain types of advocacy or representation, mail delivery and pick up, grant writing or assistance, tourism initiatives, Human Resource assistance and technical support.

- (v) “Joint venture” means a one-time grouping of two (2) or more entities in a business undertaking.
- (w) “Lowest responsible bidder” means a bidder who, after any Indian preference discounts are applied, submits the lowest bid and is considered to be fully responsible and qualified to perform the work for which the bid is submitted.
- (x) “Nation” means the Oneida Nation.
- (y) “Non-construction contract” means any contract other than a construction contract, and includes subcontracts and other agreements.
- (z) “Project” means any effort whereby the Nation or an entity of the Nation contracts for labor and/or goods or services that will support or benefit any aspect of the Nation’s government, holdings, infrastructure, workplace, economy or community.
- (aa) “Qualified trades worker” means a skilled worker qualified to perform services for the trade in which the person is trained, and includes general laborers.
- (bb) “Reservation” means all the lands within the exterior boundaries of the Reservation of the Oneida Nation, as created pursuant to the 1838 Treaty with the Oneida, 7 Stat. 566, and any lands added thereto pursuant to federal law.
- (cc) “Subcontractor” means a trade contractor, who is awarded a contract for the supply of services pursuant to a construction agreement, or a junior or secondary contractor who performs some or all of the prime contractor’s contractual obligations.
- (dd) “Trial Court” means the Trial Court of the Oneida Nation Judiciary, which is the judicial system that was established by Oneida General Tribal Council resolution GTC01-07-13-B, and then later authorized to administer the judicial authorities and responsibilities of the Nation by Oneida General Tribal Council resolution GTC-03-1917-A.
- (ee) “Tribal corporation” means a corporation chartered and/or wholly owned by the Nation pursuant to the Constitution and Bylaws of the Oneida Nation.

## 502.4. Jurisdiction

502.4-1. The Indian Preference Office shall implement, monitor, and enforce this law and other applicable laws and policies relating to Indian preference.

502.4-2. The Trial Court shall have jurisdiction over all matters related to the interpretation and enforcement of this law.

502.4-3. The Indian Preference Office and Trial Court shall have jurisdiction over all parties to any contract, subcontract, or compliance agreement to which this law applies, as well as jurisdiction over all subcontractors, employees, or other entities working with, for, or on behalf of such a party in fulfilling such contract, subcontract or compliance agreement.

## 502.5. Certification of Entities

502.5-1. *Criteria for Certification as an Indian-Owned Business.* In order to seek certification as an Indian-owned business the following criteria shall be met by the applicant entity:

- (a) There is Indian financial ownership, control and management of at least fifty-one percent (51%) of the entity. Evidence of both financial ownership and control shall be embodied in the entity’s organizational documents, including, but not limited to the documents of incorporation, stock ownership, or a partnership agreement.

- (1) *Indian Financial Ownership.* Indian financial ownership is established where the Nation, members of the Nation and/or other Indians own fifty-one percent (51%) or more of the assets and equipment, receive fifty-one percent (51%) or more of distributed net profits, and would receive fifty-one percent (51%) or more of the entity's assets upon dissolution.
- (2) *Indian Control.* Indian control is established where the Nation, member of the Nation and/or other Indian owner(s) maintain a minimum of fifty-one percent (51%) of voting rights or other controlling decisional authority.
- (3) *Indian Management.* Indian Management is established where an Indian owner(s) is directly involved in the entity's management, this can be shown where:
  - (A) at least one (1) Indian owner is directly involved in the daily operations of the entity on a full-time basis and in a senior-level position; or
  - (B) at least one (1) Indian owner is responsible for the oversight of operations, even though the daily operations are conducted by non-owner employees.
- (b) The entity can demonstrate financial responsibility, including but not limited to, evidence of an adequate line of credit, contributions of sufficient working capital, applicable required bonding and insurance, materials and/or equipment necessary to perform applicable work.
- (c) The entity can provide past and current licensing or certifications, including any penalties, or other punitive actions or debarments taken by any licensing body within the past ten (10) years.

502.5-2. *Application.* The applicant entity shall submit a completed and signed application to the Indian Preference Office, along with any documentation proving the entity meets the criteria for certification of an Indian-owned business.

- (a) Upon receiving an application, the Indian Preference Office may interview the applicant and/or request additional information as may be necessary to make a determination regarding certification.

502.5-3. *Certification Determination.* Within thirty (30) days of receiving the application and any additional requested information, the Indian Preference Office shall inform the applicant of a determination to:

- (a) grant the certification;
- (b) deny the certification, including a full written explanation of the reason for the denial; or
- (c) grant probationary certification for a period of up to one (1) year, if so determined by the Indian Preference Office for reasonable and just cause.
  - (1) During the probationary period, the applicant shall satisfy any conditions imposed by the Indian Preference Office.
  - (2) The Indian Preference Office shall monitor the activities of the applicant, and may request and receive such information as necessary to ensure compliance with this law.
  - (3) The Indian Preference Office shall either grant or deny full certification at the end of the probationary period, or upon petition by the applicant, whichever occurs first.

502.5-4. Once an applicant entity has been granted certification, the Indian Preference Office shall mail a certificate to the entity. Granting an entity certification does not convey any comment regarding the ability of the entity to perform any work nor does it guarantee that an entity has met all the qualifications to obtain work under any particular contract where Indian preference may be applied.

502.5-5. *Notification Requirements.* A certified entity shall report the following to the Indian Preference Office within ten (10) business days of such an occurrence:

- (a) changes in the ownership or control status of the entity;
- (b) suspension, revocation, lapse or loss of any licensing, certification, insurance, bonding, or credit lines; and/or (c) any other changes that could:
  - (1) affect an entity's eligibility for certification;

- (2) affect the financial liability of any entity, contracting party or the Nation; and/or
- (3) alter the status of the qualifications of the entity.

502.5-6. *Certification Renewal.* Certification is granted on an annual basis and shall lapse after one (1) year unless renewed.

- (a) To apply for a renewal certification, each certified entity shall complete and return a renewal application and annual reporting form so that the Indian Preference Office may update its records.
- (b) Annual renewal notices, applications and reporting forms shall be mailed to each certified entity at least thirty (30) days prior to the expiration of an entity's certification; however, the responsibility for renewal is upon the entity.
- (c) *Exemption for Tribal Corporations.* Tribal corporations shall be exempt from the requirement to renew certification on an annual basis. Certification for a Tribal corporation is granted until such a time that the Indian Preference Office is made aware that there have been changes that may affect the certification status of a Tribal corporation in accordance with the notification requirements of section 502.5-5.

(1) When a Tribal corporation complies with the notification requirements of section 502.5-5 the Tribal corporation shall also apply for renewal of its certification.;

- (A) The Indian Preference Office shall provide the Tribal corporation with a renewal application and annual reporting form.
- (B) The Tribal corporation shall return the renewal application and annual reporting form to the Indian Preference Office ten (10) days.

502.5-7. *Open Records.* In accordance with the Nation's laws and policies governing open records, general, non-proprietary and non-private information provided for the purposes of acquiring certification shall be considered open records and available for public inspection. Provided that, all information given for purposes of receiving certification, including financial information, is subject to internal audit of the Nation.

502.5-8. *Joint Ventures.* All joint ventures seeking certification as an Indian-owned business shall submit documentation of the business arrangements of the joint venture in addition to the required documentation for certification.

- (a) Certification for a joint venture shall be issued on a project specific basis.

502.5-9. *Brokers, Agents and Franchises.*

- (a) *Brokers.* Brokers shall be certified as an Indian-owned business only if they are dealers who own, operate or maintain a store, warehouse or other establishment in which the commodities being supplied are bought, kept in stock and sold to the public in the usual course of business; provided that this requirement shall not apply where the applicant demonstrates that it is not customary and usual in the area of the trade in question for a broker to maintain an establishment and to keep commodities in stock.
  - (1) To qualify as an Indian-owned business, the broker shall provide conclusive evidence that the broker is an independent contractor and not an agent of a nonIndian owned business.
  - (2) The broker shall also provide proof that he owes no fiduciary responsibility nor has a fixed or permanent relationship to any one company. A broker shall hold himself or herself out for employment to the public generally and that the employment is not that of being a special agent for a single client.
- (b) *Agents.* Agents who are employees of a non-Indian-owned business or who merely represent a company, such as an insurance agent or real estate agent for a non-Indianowned business, shall not be certified as an Indian-owned business.
- (c) *Franchises.* A franchise may be certified as an Indian-owned business if the franchisee does not pay the franchisor a share or percentage of revenue or profits, but only compensates the franchisor through



licensing, royalty and franchise fees as set out by contract, and/or for services provided, such as training and advising.

502.5-10. *Fronts are Prohibited.* Entities shall be disqualified from certification as an Indian-owned business in all situations where the entity operates as a front in order to unfairly take advantage of Indian preference granted under this law to Indian-owned businesses.

(a) The Indian Preference Office shall not certify entities that operate solely as fronts. (b) No entity shall manipulate its business structure or misrepresent the roles of Indian individuals or entities in such a way as to become eligible for Indian preference in a manner inconsistent with the purpose and intent of this law.

(c) Examples of fronts include but are not limited to:

(1) Entities that represent that they are exercising management control of a project in order to qualify for Indian preference when in fact such management control is exercised by a non-Indian entity;

(2) Entities where Indians have senior management titles without the correlating responsibilities, control, or knowledge of operations; where the entity only qualifies for certification because an Indian holds that senior management role; (3) Entities, not including legitimate brokers, that derive profit only by providing goods or services at an increased cost, where such goods or services could be acquired directly on the open market and/or from the entity's source without paying a marked-up cost; and/or

(4) Any other situation where the Indian Preference Office determines that the application of Indian preference would in fact predominantly or substantially benefit non-Indians or non-Indian-owned businesses; or where Indians or Indian-owned businesses only benefit by assisting the non-Indian or non-Indian-owned business with receiving the contract.

## 502.6. Application of Indian Preference to Contracts

502.6-1. *Application of the Law.* Except where prohibited or limited by law or grant funding requirements, this law shall apply to all contracts over three thousand dollars (\$3,000) that meet the requirements of (a) and/or (b) below:

(a) This law shall apply to:

(1) all contracts, subcontracts, and compliance agreements to which the Nation is a party, and all contracts, subcontracts and compliance agreements that are entered into on behalf of, or for the benefit of the Nation, whereby goods and services are provided on or near the Reservation; and

(2) all subcontractors, employees, or other entities working with, for, on behalf of a party to a contract, subcontract or compliance agreement as identified in (1), in fulfilling such contract, subcontract, or compliance agreement.

(b) *Tribal Corporations.* This law shall apply to Tribal corporations to the extent such corporations enter into contracts with the Nation.

502.6-2. *Non-Applicability of the Law.*

(a) *Indian Preference in Hiring of Employees of the Nation.* The standards set out in this law shall not apply to preference as applicable to employees hired through the Nation's Human Resources Department or pursuant to an employment contract.

(b) *Internal Services and Enterprises.* The application of Indian preference shall be superseded in specific situations in accordance with the following:

- (1) The Nation shall exclusively utilize internal services and enterprises whenever an internal service of the Nation or enterprise could or does provide the necessary goods and services in the ordinary course of business.
- (2) If an internal service or enterprise is unable to fulfill some or all of the requirements of a contract, then the provisions of this law shall apply to any outsourcing conducted by the internal service or enterprise.

502.6-3. *Contract Specifications Review.* Prior to the posting or announcement of a contract for any project of the Nation, the specifications for such project shall be submitted to the Indian Preference Office.

- (a) Within five (5) business days of receiving the specifications of the project the Indian Preference Office shall, with experts identified from other entities of the Nation, review the specifications, including bidding requirements, to ensure that there are no unnecessary and/or unjustifiable restrictions that may:
  - (1) preclude certified entities from bidding or being eligible to fulfill the contract or subcontract;
  - (2) disqualify qualified trades workers from employment opportunities created under such contract or subcontract; and/or
  - (3) create conditions that would make bidding, compliance, or employment unduly burdensome for qualified trades workers or certified entities.
- (b) *Unbundling a Contract.* The Indian Preference Office may require that specific portions of a contract be outsourced to internal services, enterprises, certified entities and/or qualified trades workers, even if a single entity is capable of providing all of the goods and/or services required under the contract. Provided that, such outsourcing shall not cause undue hardship, unnecessary delay or additional expenses in completing the project.

502.6-4. In soliciting bids, the entity offering the contract shall indicate that Indian preference shall be applied in accordance with this law.

502.6-5. *Cooperative Agreements.* Within the scope of authority defined in this law, the Indian Preference Office may enter into cooperative agreements with federal and state agencies, subject to the approval of the Oneida Business Committee.

502.6-6. *Cultural Setting of Contracts.* All parties to a contract to which this law applies shall recognize that any operations are taking place within a unique cultural setting within the Nation. Every contractor shall make reasonable accommodations to the customs and beliefs of all Indian workers so as to promote rather than hinder the employment of Indians.

- (a) If an Indian worker wishes to attend any traditional cultural activities or ceremonies, the worker shall provide reasonable advance notice to the contractor in requesting such time off.
- (b) Where attendance at traditional cultural activities or ceremonies requires a worker to take time off from a regularly scheduled shift or workday, such time may be paid or unpaid, at the discretion of the employer or as established by contract or compliance agreement.

502.6-7. *Employees of the Nation.* In the execution of employment duties and in accordance with the Nation's laws and policies governing employment, employees of the Nation shall follow this law in following contracting and bidding procedures for the Nation or entities of the Nation. (a) The Indian Preference Office shall establish a training process for entities of the Nation that do contracting or bidding as a regular function of their duties.

502.6-8. *Contracts and Attachments.* All contracts this law applies to shall:

- (a) Stipulate that compliance with this law is required, and that violation of any portion of this law or applicable compliance agreement may be deemed a material and substantial breach of contract, enforceable:

- (1) As set forth by the terms of the original contract for a breach of contract; and

(2) In accordance with the provisions of this law.

(b) Reference this law, and shall contain an acknowledgment clause, whereby the contractor shall agree to the following:

(1) The contractor has read and understands the provisions of this law;

(2) The contractor understands how this law affects the contractor's rights and responsibilities; and

(3) The contractor agrees that the provisions of this law shall govern the performance of the parties.

(c) Reference the Nation's laws governing vendor licensing, and provide the contracting parties with directions on how to access that document.

502.6-9. *Applying Indian Preference to Non-Construction Contracts.* Where more than one (1) bid is received for a non-construction contract, an Indian preference percentage discount of five percent (5%) shall be applied to all bids received from certified Indian-owned businesses.

502.6-10. *Applying Indian Preference to Construction Contracts.* Where more than one (1) bid is received for a construction contract, the discount applied to bids from certified Indian-owned businesses shall be:

(a) ten percent (10%) of the first fifty thousand dollar (\$50,000) segment of a bid;

(b) plus nine percent (9%) of the next fifty thousand dollar (\$50,000) segment of a bid; (c) plus eight percent (8%) of the next one hundred thousand dollar (\$100,000) segment of a bid;

(d) plus seven percent (7%) of the next one hundred thousand dollar (\$100,000) segment of a bid;

(e) plus six percent (6%) of the next one hundred thousand dollar (\$100,000) segment of a bid;

(f) plus five percent (5%) of the next one hundred thousand dollar (\$100,000) segment of a bid;

(g) plus four percent (4%) of the next five hundred thousand dollar (\$500,000) segment of a bid;

(h) plus two percent (2%) of the next one million dollar (\$1,000,000) segment of a bid; and

(i) plus one percent (1%) of any amount over two million dollars (\$2,000,000).

502.6-11. *Awarding the Contract.* After the appropriate discount has been subtracted from preferred bids, the following shall be used to determine which bidder is awarded the contract: (a) If a bid from a certified entity is less than the total of the apparent low bid after Indian preference is applied, then the contract shall be awarded to the certified entity.

(b) If none of the certified entity bids are less than the total of the apparent low bid after the Indian preference discount is applied, the contract shall be awarded to the lowest responsible bidder.

(c) Bid shopping is prohibited.

502.6-12. *Monitoring the Contract.* Once a contract is awarded to an entity, the Indian Preference Office shall perform the following monitoring duties:

(a) Perform on-site inspections to verify compliance with this law;

(b) Require and review weekly workforce reports;

(c) Provide training to assist certified entities with understanding their rights and abilities under this law; and

(d) Receive feedback from contractors regarding the performance of any certified entity or qualified trades worker.

502.6-13. In the event that a dispute may arise regarding this law or a compliance agreement, all affected parties shall cooperate in good faith with the Indian Preference Office toward a mutually satisfactory resolution.

## 502.7. Compliance Agreements

502.7-1. *Compliance Agreements.* Once a bid has been accepted, but before work commences on any portion of a contract or subcontract, each contractor shall meet with the Indian Preference Office to negotiate and execute a compliance agreement. All contractors and subcontractors shall comply with the terms of any compliance agreement executed in accordance with this law. 502.7-2. *Contents of a Compliance Agreement.*

A compliance agreement shall include, but is not limited to, the following information:

- (a) Numerical hiring goals and timetables that specify the minimum number of Indians that must be utilized per contract dollar; and
- (b) Compensation of qualified trades workers including wage scale, salaries and other benefits. Compensation shall be determined based on the prevailing wage scales of the Nation and/or federal or state governments.

502.7-3. *Term of a Compliance Agreement.* Where a contract lasts for more than one (1) year, compliance agreements shall be reviewed annually and revised as necessary to reflect changes in hiring plans or the number of certified entities available.

502.7-4. Unless prior written consent of the Indian Preference Office has been received, a contractor shall not deviate from an executed compliance agreement by adding or removing any subcontracts, subcontractors or positions filled by qualified trades workers or certified entities, or by filling a vacancy with a non-qualified trades worker or a non-certified entity.

502.7-5. *Limited Waivers.* The Indian Preference Office shall establish standard operating procedures to provide for emergency conditions and situations whereby a limited waiver of compliance may be authorized, in situations where a contractor has made a significant and documented good faith effort to achieve compliance, or can demonstrate that compliance is not practical for reasons other than pricing.

## 502.8. Skills Bank and Qualified Trades Workers

502.8-1. The Indian Preference Office shall establish and administer a Skills Bank to assist with providing Indians and first-generation descendants with employment opportunities. The goal of the Nation is to achieve one hundred percent (100%) participation of qualified trades workers on projects.

- (a) The Indian Preference Office shall identify, initiate, and sponsor training, internship, and apprenticeship opportunities necessary in order to increase the pool of qualified trades workers and to assist Indians in becoming qualified in the various job classifications used by employers.
- (b) The Indian Preference Office shall cooperate with other programs of the Nation to provide counseling and support to assist Indians in retaining employment.

502.8-2. The Skills Bank shall be the exclusive referral source under this law, representing the official compilation of qualified trades workers eligible for Indian preference in accordance with this law. Skills Bank listings shall include the names and qualifications of the qualified trades workers. The Indian Preference Office shall regularly update the Skills Bank listings.

502.8-3. Entities required to fill positions in accordance with this law and/or a compliance agreement under section 502.7, shall contact the Indian Preference Office prior to the commencement of any work.

- (a) Except where prohibited by law or grant funding requirements, the entity shall hire qualified trades workers from the Skills Bank in the following order of priority: (1) Members of the Nation;
- (2) First generation descendants of the Nation; and then
- (3) Members of other federally-recognized Indian tribes.

(b) If a law or grant funding requirement prohibits the hiring of qualified trades workers in accordance with section 502.8-3(a), qualified trades workers shall be hired in accordance with the requirements of said law or grant.

(c) If the necessary labor cannot be acquired from the Skills Bank, then a limited waiver may be granted by the Indian Preference Office.

502.8-4. In order to be added to the Skills Bank, an applicant shall submit a completed application and documentation of the following:

(a) proof of enrollment or proof that the individual is a first-generation descendant of the Nation;

(b) education; including degrees, diplomas, apprenticeships, internships or continuing education training related to the field;

(c) proof of a driver's license, including any endorsements, if applicable;

(d) if the worker is seeking to be listed as a qualified trades worker for a specific trade, then the worker shall provide specific information related to that trade, including:

(1) past and current licensing;

(2) credentials and certifications; and

(3) information related to penalties or punitive actions taken by any licensing body within the past ten (10) years.

502.8-5. Placing an applicant in the Skills Bank as a qualified trades worker confers recognition that he or she is eligible to receive Indian preference in accordance with this law. A qualified trades worker shall be qualified for Indian preference for employment for a particular skill or trade if he or she meets the minimum qualifications for a particular skill or trade.

502.8-6. *Wage and Hour Standards, Layoffs and Terminations, Call-Backs, Promotions, Unions.*

(a) Every contractor utilizing qualified trades workers shall ensure that such workers receive equal compensation, including overtime pay, and shall have equal work standards, that are provided to other employees. Contractors that hire qualified trades workers in order to comply with this law, but do not utilize those workers in a manner similar to other employees are not maintaining equal work standards.

(b) In making any layoffs or terminations, all contractors shall notify the Indian Preference Office prior to laying off or terminating a qualified trades worker.

(1) No qualified trades worker with at least minimum qualifications for the job classification shall be terminated or laid off so long as a non-Indian employee in the same craft with similar skills remains employed. If the contractor lays off by crews, qualified trades workers shall be transferred to any crew that will be retained, as long as there are non-Indian employees in the same craft employed elsewhere under the same contract.

(2) No contractor shall terminate or lay off any qualified trades worker pursuant to this law, without documented good cause. The contractor shall promptly replace the qualified trades worker with another qualified trades worker.

(3) When a contractor begins to call back laid-off employees, that contractor shall notify the Indian Preference Office and shall call back qualified trades workers before bringing back other employees.

(c) Qualified trades workers and certified entities shall not be required to affiliate with organized labor for employment under this law. The mere absence of affiliation with organized labor shall not disqualify a qualified trades worker from employment or contracting where that worker is otherwise qualified. A qualified trades worker shall not be guaranteed to receive the benefits of a union contract, other than wage scales, unless the worker elects to join the union.

502.8-7. *Construction Contracts: Core Work Crew.* As a condition of a construction contract award, the contractor shall identify its core work crew, including those core work crew employees utilized by known subcontractors. If such employees are approved by the Indian Preference Office, they may be employed on the project without regard to Indian preference. Provided that, core work crew employees shall at no time displace qualified trades workers and/or potential qualified trades workers by performing work outside their trade or skill.

- (a) For the purposes of employment on a project, the Indian Preference Office and the contractor, and any subcontractor, shall negotiate the designated members of the contractor's core work crew.
- (b) Any contractor that fills vacant positions immediately prior to undertaking work pursuant to a contract to which this section applies shall provide evidence acceptable to the Indian Preference Office that such actions were not intended to circumvent the provisions of this law.
- (c) A contractor shall not use extraneous qualification criteria or other personnel requirements that prevent qualified trades workers from being employed, unless the contractor is able to demonstrate that such criteria or requirements are required by regulatory compliance.

## 502.9. Investigations and Enforcement

502.9-1. *Complaints.* An individual or entity may file a written complaint with the Indian Preference Office if aggrieved by an act of non-compliance with:

- (a) this law;
- (b) a compliance agreement; and/or
- (c) any standard operating procedure issued pursuant to this law.

502.9-2. *Contents of the Complaint.* A complaint shall include information that will reasonably enable the Indian Preference Office to understand the general nature of the complaint and carry out an investigation, such as evidence of any discriminatory practices, alleged misconduct, or other non-compliance.

502.9-3. *Complaint Investigation.* Upon receipt of a complaint or after witnessing noncompliance with this law while conducting its monitoring duties, the Indian Preference Office shall conduct an investigation.

- (a) In conducting an investigation to determine if the complaint has merit, the Indian Preference Office shall be authorized to:
  - (1) inspect and copy all relevant records; (2) interview and speak to workers; and
  - (3) conduct inspections of the job site.
- (b) Information collected during an Indian Preference Office investigation shall be kept confidential unless disclosure is necessary or required as part of any judicial or administrative proceeding or in accordance with a law of the Nation.
  - (1) Any report or recommendation prepared by the Indian Preference Office for use at a hearing shall be promptly released to the complainant and alleged violator.
- (c) If the Indian Preference Office receives a complaint or information that an entity is operating in a manner that is harmful to the health, safety, or welfare of the Nation or community, the Indian Preference Office shall immediately refer the complaint or information to the appropriate department or authority of the Nation for investigation.
  - (1) The referral of a complaint does not prohibit the Indian Preference Office from its independent investigation of such complaint or information for purposes of ensuring compliance with this law.
  - (2) The Indian Preference Office shall have the authority to review the results of any other investigation conducted by another department or authority of the Nation in accordance with the

Nation's laws and policies governing open records. 502.9-4. *Alleged Violation Has No Merit.* If the Indian Preference Office determines that the alleged violation has no merit, the Indian Preference Office shall notify all parties in writing that the complaint shall be closed.

- (a) The complainant may file a complaint to contest this decision with the Nation's Trial Court within ten (10) business days after issuance of such notice.
- (b) The Trial Court shall then conduct an in-camera inspection of the investigation completed by the Indian Preference Office. During an in-camera inspection only a judge may review the information obtained by the Indian Preference Office during the investigation as this information is confidential and disclosure is not necessary.
- (c) If after reviewing the Indian Preference Office's investigation, the Trial Court determines the alleged violation has no merit, the Trial Court shall notify all parties in writing that the matter will be dismissed and no further appeals of the matter will be accepted.
- (d) If after reviewing the Indian Preference Office's investigation the Trial Court determines that there is sufficient evidence of a genuine and material issue of noncompliance, the Trial Court shall order the Indian Preference Office to take action in accordance with section 502.9-5.

502.9-5. *Alleged Violation Has Merit.* If the Indian Preference Office determines that the alleged violation has merit and there is sufficient evidence of a genuine and material issue of non-compliance, the Indian Preference Office may take action to resolve the complaint.

- (a) The Indian Preference Office may take any of the following actions to resolve the complaint:
  - (1) Attempt to reach an informal or formal resolution of the alleged noncompliance;
    - (A) If a formal resolution is reached, any agreement shall be in writing and signed by all parties. The issue shall then remain in abeyance for the term of the contract during which time all parties shall comply with the terms of the written agreement. Breach of the terms of the written agreement may be a cause of action for litigation before the Trial Court.
  - (2) Issue a notice of non-compliance to the entity by certified mail;
    - (A) The notice shall state the specific violation(s) alleged, the requirements that must be met to ensure compliance with this law, and shall provide a reasonable amount of time, not to exceed thirty (30) days, wherein the entity shall provide evidence that it has taken the steps necessary to come into compliance.
  - (3) Place the entity's certification in probationary status for a period not to exceed six (6) months; or suspend, revoke, or deny renewal of the entity's certification;
    - (A) Once certification is revoked, an entity shall not be eligible to apply for re-certification until one (1) year has passed from the effective date of the revocation.
    - (B) At any time that certification is suspended, revoked, or has lapsed, a formerly certified entity shall not qualify for Indian preference.
    - (C) Where a certified entity loses certification:
      - (i) the contractor may be required to replace that entity with another certified entity if the work has not begun or performance under a contract has not commenced, unless replacement is impossible or would cause undue hardship; or
      - (ii) the Indian Preference Office may authorize the contractor to continue to utilize that entity without regard to Indian preference if work has already begun or performance under a contract has commenced.
  - (4) Issue a fine;
    - (A) The Indian Preference Office shall be delegated authority to develop a fine and penalty schedule that may be imposed upon any person or entity violating provisions of

this law. The fine and penalty schedule shall be adopted by the Oneida Business Committee through resolution.

(B) No fines or penalties may be assessed against the Nation, the Indian Preference Office, or other department of the Nation, or employees engaged in their official duties under this law.

- (5) Re-negotiate a compliance agreement with the contractor to include additional opportunities for qualified trades workers or certified entities; and/or (6) Request the appropriate entity withdraw any licensing issued by the Nation. (b) An individual or entity may contest an action taken by the Indian Preference Office by filing a complaint with the Trial Court within ten (10) business days after the date of issuance of the Indian Preference Office's decision.

502.9-6. *Additional Enforcement Measures.* If the Indian Preference Office is unable to facilitate a satisfactory resolution, and a notice of non-compliance or action against a certified entity's certification has not resulted in a successful resolution, the Indian Preference Office may file an action with the Trial Court, seeking appropriate relief, including but not limited to:

- (a) An injunction;
- (b) Specific performance, including but not limited to:
  - (1) reinstatement of a qualified trades worker at the previous wage;
  - (2) immediate removal of employees hired in violation of this law; and/or
  - (3) employment, promotion or additional training for Indian preference-eligible parties injured by a violation;
- (c) Payment of back pay, damages, and/or costs associated with the enforcement of an order issued by the Trial Court, including but not limited to filing fees, attorney fees, and/or costs incurred by the Indian Preference Office in bringing an action. Provided that, no money damages may be claimed in any suit against the Nation, the Indian Preference Office or other departments of the Nation, or officials of the Nation or employees engaged in their official duties under this law; and/or
- (d) Any other action the Trial Court deems lawful, equitable, and necessary to ensure compliance with this law and to alleviate or remedy any harm caused by non-compliance. 502.9-7. Although relief granted by the Trial Court may benefit an individual qualified trades worker, certified Indian preference entity, or other individual or entity, neither the Indian Preference Office nor the Nation represents those individuals and/or entities in any action for non-compliance with this law.

502.9-8. *Cease-and-Desist Orders.* The Oneida Police Department is hereby expressly authorized and directed to enforce such cease-and-desist or related orders as may from time to time be properly issued by the Trial Court. Such orders shall require a decree or order to render them enforceable. The Oneida Police Department shall not be civilly liable for enforcing such orders so long as the Trial Court signs the order.

502.9-9. *Retaliatory Action Prohibited.* No entity shall punish, terminate, harass or take any other adverse personnel or hiring action in retaliation for a party's exercise of Indian preference rights under this law. However, this section shall not prohibit action that can be reasonably justified as taken in good faith based on documented employee performance.

*End.*

---

Adopted BC-03-27-13-B  
Amended BC-04-08-20-I



**Document 00 22 01 – INDIAN PREFERENCE VENDORS**

2. GENERAL

2.1. INDIAN PREFERENCE VENDORS

- A. The Certified Indian Owned Businesses on the list following this section, will be notified of the project and can submit sub-bids to the General Contractors for portions of the Work.
- B. If Certified Indian Owned Businesses wish to bid as a General Contractor, they are still required to get sub-bids from other Certified Indian Owned Businesses.
- C. The Oneida Nation will notify the Certified Indian Owned Business List, informing them of the project and providing them a listing of the invited General Contractors or the listing of current plan holders on public bid projects.
  - 1. General Contractors shall still contact Certified Indian Owned Businesses to attempt to get bids.
- D. Comparison of Certified Indian Owned Business bids to non-Indian owned business bids will be made during the post-bid evaluation, at percentages denoted in the Oneida Indian Preference in Contracting Law.
- E. For questions regarding the Certified Indian Owned Business list, please contact:

Stephanie Metoxen – Indian Preference Coordinator  
Division of Public Works  
P.O. Box 365  
Oneida, WI 54155

E-Mail: [smetoxen@oneidanation.org](mailto:smetoxen@oneidanation.org)  
Phone: 920-869-4540

END OF 00 22 01 – INDIAN PREFERENCE VENDORS

INDIAN PREFERENCE DEPARTMENT – CERTIFIED INDIAN OWNED BUSINESS LIST FOLLOWS

# Indian Preference Vendor List

DEPARTMENT OF PUBLIC WORKS BUILDING

W1278 RANCH RD ONEIDA P.O. Box 365 Oneida, WI 54155

Office: 920-869-1059 Ext. 2016,

Fax: 920.869-1559

June 28, 2023

## Table of Contents

<u>ASBESTOS AND LEAD ABATEMENT</u> .....	3	<u>AUTO</u>
<u>BODY &amp; SERVICE</u> .....	3	<u>BAKERY</u>
.....	3	
<u>BUILDING/REMODEL</u> .....	3	
<u>BUILDING MATERIALS &amp; SUPPLIES</u> .....	4	
<u>CIVIL/INFRASTRUCTURE ENGINEERING</u> .....	4	
<u>CONCRETE</u> .....	4	
<u>CONFERENCE ROOMS</u> .....	5	
<u>CONSTRUCTION</u> .....	5	
<u>CONSTRUCTION &amp; INDUSTRIAL SUPPLIES</u> .....	6	
<u>CONSTRUCTION MANAGEMENT SERVICES</u> .....	6	
<u>CONSULTANT</u> .....	6	
<u>DEMOLITION</u> .....	7	
<u>DRYWALL AND INSULATION</u> .....	7	
<u>EXCAVATION</u> .....	8	
<u>FIRE ALARM/LIFE SAFETY, ACCESS CONTROL &amp; SECURITY SYSTEMS</u> .....	8	
<u>FLOORING</u> .....	8	
<u>FOOD SERVICE</u> .....	8	<u>GAMING</u>
<u>EQUIPMENT/UNIFORMS</u> .....	8	<u>GENERAL</u>

<b><u>CONTRACTOR</u></b> .....	<b>9</b>	<b><u>H.V.A.C.</u></b>
.....	9	
<b><u>HOME RENOVATION AND REPAIR</u></b> .....	<b>9</b>	
<b><u>INTER-TRIBAL DEPARTMENTS &amp; ENTERPRISES</u></b> .....	<b>10</b>	
<b><u>LANDSCAPE &amp; LAWN CUTTING</u></b> .....	<b>11</b>	
<b><u>OFFICE SUPPLIES</u></b> .....	<b>11</b>	
<b><u>PAINTING</u></b> .....	<b>11</b>	
<b><u>PHOTOGRAPHER</u></b> .....	<b>11</b>	
<b><u>PLUMBING</u></b> .....	<b>12</b>	
<b><u>PRINT SHOP</u></b> .....	<b>12</b>	
<b><u>SAFETY CONSULTING</u></b> .....	<b>12</b>	
<b><u>SITE PREPERATION</u></b> .....	<b>12</b>	
<b><u>SNOWPLOWING, RESIDENTIAL/COMMERCIAL</u></b> .....	<b>12</b>	
<b><u>SOLID WASTE LANDFILL</u></b> .....	<b>13</b>	
<b><u>STRUCTURED CABLING, CCTV</u></b> .....	<b>13</b>	
<b><u>TRUCKING</u></b> .....	<b>13</b>	
<b><u>TELECOMMUNICATIONS, ELECTRICAL &amp; SPECIAL SYSTEMS</u></b> .....	<b>13</b>	<b><u>VOICE</u></b>
<b><u>&amp; DATA COMMUNICATIONS SYSTEMS</u></b> .....	<b>13</b>	
<b><u>WATER &amp; SEWER LINE CONSTRUCTION</u></b> .....	<b>13</b>	
<b><u>WINDOW CLEANING</u></b> .....	<b>14</b>	

## **ASBESTOS AND LEAD ABATEMENT**

Mission Support Services 1033 N. Mayfair Road, Suite 202 Milwaukee, WI. 53226 E-Mail: MKunstman@oesllc.com Web Site: <a href="http://www.ms2llc.com">www.ms2llc.com</a>	Matt Kunstman Vendor #144118 Oneida Nation SBA Certified	(920) 360-6710 cell (920) 884-3970 (414) 257-2492fax
---	---	--

## **AUTO BODY & SERVICE**

Goss Auto Body, Inc. & Midway Service Center & Repair 629 Olde Midway Road	Ronald Goss Vendor #NONE	(920) 810-7487 cell (920) 725-2022
--	-----------------------------	---------------------------------------

Menasha, WI. 54952  
E-Mail: [Ronnie@gossautobody.com](mailto:Ronnie@gossautobody.com)  
Website: [www.gossautobody.com](http://www.gossautobody.com)

Oneida Nation

(920) 725-7080 fax

Web's Kustom Touch Auto Body  
3792 Cty Rd U  
Oneida, WI. 54155  
Email [webskrap@yahoo.com](mailto:webskrap@yahoo.com)

Donald & Jennifer Webster (920) 869-WEBS  
Vendor #104568  
Oneida Nation

## **BAKERY**

WT Creations/Sister Bread  
W280 Reformatory Rd  
Oneida WI, WI 54155  
E-Mail: [wthatsme@yahoo.com](mailto:wthatsme@yahoo.com)

Winnifred L. Thomas (920) 869-1150  
(920) 883-1124 cell  
Vendor #135747  
Oneida Nation

## **BUILDING/REMODEL**

Align Remodeling & Construction LLC  
3701 N. Casaloma Drive  
Appleton, WI. 54913  
E-Mail: [nick@alignremodelingllc.com](mailto:nick@alignremodelingllc.com) Web  
Site:  
[www.alignremodelingllc.com](http://www.alignremodelingllc.com)

Kimberly Smith (920) 475-3685  
Vendor #

Hill Fix it LLC  
N5548 Ho Chunk Blvd  
DePere WI 54155  
E-Mail: [Hillfixitllc@gmail.com](mailto:Hillfixitllc@gmail.com)  
NAICS CODE 236118

Latsiklanunha Hill 920-413-7214 Cell  
Vendor # 920-415-6012 Home

Mission Support Services  
1033 N. Mayfair Road, Suite 202  
Milwaukee, WI. 53226  
E-Mail: [MKunstman@oesllc.com](mailto:MKunstman@oesllc.com)  
Web Site: [www.ms2llc.com](http://www.ms2llc.com)

Matt Kunstman (920) 360-6710 cell  
Vendor #144118 (920) 884-3970  
Oneida Owned (414) 257-2492fax  
SBA Certified

Maintenance and Renovation Professionals LLC  
4164 Hillcrest Rd  
Oneida WI 54155

Mary & Jermain Adams 920-819-9724 Mary  
Oneida Vendor 920-639-0847 Jermain

E-Mail Address: [maintenancerenopros21@gmail.com](mailto:maintenancerenopros21@gmail.com)

Tee Construction LLC 4150 Merrimac Way Oneida, WI 54155	Anthony Franco Oneida Vendor	(920) 865-5468
---	---------------------------------	----------------

E-Mail: [Anthonyfranco@Gmail.com](mailto:Anthonyfranco@Gmail.com)

NAICS CODE 236115, 1521

## **BUILDING MATERIALS & SUPPLIES**

Omega Fields Inc. dba, Cool Running Air Conditioners & More 3708 Playbird Rd. Sheboygan WI. 53083 E-Mail: <a href="mailto:Sean@Omegafields.com">Sean@Omegafields.com</a> Web Site: <a href="http://www.coolrunnlnghs.com">www.coolrunnlnghs.com</a>	Sean Moriarty Vendor # <a href="#">Oneida Nation</a>	Main 920-797-4602 Fax 920-476-1000 Cell 920-889-9273
--	--	--

## **CIVIL/INFRASTRUCTURE ENGINEERING**

Oneida Total Integrated Enterprise 2555 Packerland Drive Green Bay, WI. 54313 E-Mail: <a href="mailto:mkunstman@otie.com">mkunstman@otie.com</a> Website: <a href="http://www.otiesolutions.com">www.otiesolutions.com</a>	Matt Kunstman Vendor #134114 Oneida Owned SBA Certified	(920) 360-6710 cell (920) 884-3970 (920) 884-3989 fax
--	--	---

## **CONCRETE**

Josh Bailey Concrete LLC 1949 Candle Way Green Bay, WI 54304 Mail: <a href="mailto:jbconstr123@gmail.com">jbconstr123@gmail.com</a> Web Site: <a href="http://JoshBaileyConcrete.com">Josh Bailey Concrete.com</a>	Josh Bailey Vendor # 147125 Oneida Nation E-	(920) 569-9708 cell
--	--	---------------------

Meyer Contracting, Inc., 11000 93 <sup>rd</sup> Ave N Maple Grove MN 55369 Email: <a href="mailto:estimating@meyerci.com">estimating@meyerci.com</a> Website: <a href="http://meyerci.com">meyerci.com</a>	Verlyn Schoep Oneida Vendor MBE certified	Main: 763-391-5959 Fax: 763-391-5960
--	---	---

## CONFERENCE ROOMS

Radisson Hotel & Conference Center 2040 Airport Drive Green Bay, WI. 54311 Website: <a href="http://www.radisson.com/greenbaywi">www.radisson.com/greenbaywi</a>	Oneida Airport Hotel Corp. (920) 494-7300 Vendor #100047 Oneida Owned	(920) 494-9599 fax
---	---	--------------------

## CONSTRUCTION

Align Remodeling & Construction LLC 3701 N. Casaloma Drive Appleton, WI. 54913 E-Mail: <a href="mailto:nick@alignremodelingllc.com">nick@alignremodelingllc.com</a> Web Site: <a href="http://www.alignremodelingllc.com">www.alignremodelingllc.com</a>	Kimberly Smith Vendor #	(920) 475-3685
---	----------------------------	----------------

Greenfire Management Services, LLC 3215 W. State Street Ste.200 Milwaukee, WI 53208 <a href="http://www.greenfire.com">www.greenfire.com</a> Email Address: NIGP Codes 236116, 236210, 236220, 531390	Jeb Meier Vendor # Potawatomi Tribe MBE Certified	(414)290-9400 (414-290-9435 Fax (715)-210-5356 cell
--	--	---

Hill Fix it LLC N5548 Ho Chunk Blvd DePere WI 54155 E-Mail: <a href="mailto:Hillfixitllc@gmail.com">Hillfixitllc@gmail.com</a> NAICS CODE 236118	Latsiklanunha Hill Vendor #	920-413-7214 Cell 920-415-6012 Home
--	--------------------------------	--

Maintenance and Renovation Professionals LLC 4164 Hillcrest Rd Oneida WI 54155 E-Mail Address: <a href="mailto:maintenancerenopros21@gmail.com">maintenancerenopros21@gmail.com</a>	Mary & Jermain Adams Oneida Vendor	920-819-9724 Mary 920-639-0847 Jermain
--	---------------------------------------	---

Mavid Construction Services, LLC. 1609 Western Avenue, Suite A	Zoar Fulwilder David Montiel	(920) 965-0271 (o) (888) 494-0504 fax
---	---------------------------------	--

Green Bay, WI. 54304 E-Mail: <a href="mailto:Zoar@mavidconstruction.com">Zoar@mavidconstruction.com</a>	Edward Martin Vendor # 137381	920) 655-6023 cell
--	----------------------------------	--------------------

Meyer Contracting, Inc., 11000 93 <sup>rd</sup> Ave N Maple Grove MN 55369 Email: <a href="mailto:estimating@meyperci.com">estimating@meyperci.com</a> Website: meyperci.com	Verlyn Schoep  Indian Vendor MBE certified	Main:763-391-5959 Fax: 763-391-5960
--	---	--

Meltz Industries LLC N7565 Bodart Court Seymour. WI54165 E-Mail: <a href="mailto:Cmeltz@meltzindustries.com">Cmeltz@meltzindustries.com</a> Website: <a href="http://www.meltzindustries.com">www.meltzindustries.com</a>	Crystal & Charles Vendor #144945 Oneida Nation WBE Certified MDE Certified	(920) 609-1548 (920)-850-3994
---	--	----------------------------------

Tee Construction LLC 4150 Merrimac Way Oneida, WI 54155 E-Mail: <a href="mailto:Anthonyfranco@Gmail.com">Anthonyfranco@Gmail.com</a>	Anthony Franco Oneida Vendor  NAICS CODE 236115, 1521	(920) 865-5468
---	--	----------------

White Buffalo Trucking LLC. W1357 Tall Feather Way Seymour, WI. 54115 E-Mail: <a href="mailto:ahacker1@new.rr.com">ahacker1@new.rr.com</a>	Amy & Cale Hacker Vendor # 147141 Oneida Nation DBE Certified	(920) 737-4520 (920) 737-4520 cell
---	--	---------------------------------------

## **CONSTRUCTION & INDUSTRIAL SUPPLIES**

Omega Fields Inc. dba, Cool Running Air Conditioners & More 3708 Playbird Rd. Sheboygan WI. 53083  E-Mail: <a href="mailto:Sean@Omegafields.com">Sean@Omegafields.com</a> Web Site: <a href="http://www.coolrunnlnghs.com">www.coolrunnlnghs.com</a>	Sean Moriarty  Vendor # Oneida Vendor	Main 920-797-4602 Fax 920-476-1000 Cell 920-889-9273
--	--	--

Mission Support Services 1033 N. Mayfair Road, Suite 202 Milwaukee, WI. 53226 Email: <a href="mailto:MKunstman@oesllc.com">MKunstman@oesllc.com</a> MBE Certified Web Site: <a href="http://www.ms2llc.com">www.ms2llc.com</a>	Matt Kunstman Vendor # 134114 Oneida Owned	(920) 360-6710 cell (920) 884-3970 (414) 257-2492 Fax
--	--	---

## **CONSTRUCTION MANAGEMENT**

Greenfire Management Services, LLC 3215 W. State Street Ste.200 Milwaukee, WI 53208 <a href="http://www.greenfire.com">www.greenfire.com</a> Email Address: <a href="mailto:bids@greenfire.com">bids@greenfire.com</a> NIGP Codes 236116, 236210, 236220, 531390	Jeb Meier Vendor # Potawatomi Tribe MBE Certified	(414)290-9400 (414-290-9435 Fax (715)-210-5356 cell
---	--	---

## **CONSULTANT**

Oneida Total Integrated Enterprise 2555 Packerland Drive Green Bay, WI. 54313 E-Mail: <a href="mailto:mkunstman@otie.com">mkunstman@otie.com</a> Website: <a href="http://www.otiesolutions.com">www.otiesolutions.com</a>	Matt Kunstman Vendor #134114 Oneida Vendor SBA Certified	(920) 360-6710 cell (920) 884-3970 (920) 884-3989 fax
Universal Consulting Solutions LLC 2920 Freedom Rd Oneida, WI 54155 E-Mail: <a href="mailto:tracey@uconsolutions.com">tracey@uconsolutions.com</a> Website/URL: <a href="https://www.uconsolutions.com">https://www.uconsolutions.com</a>	Tracey Cordova Vendor # Oneida Vendor	(920) 606-4456

## **DEMOLITION**

Meyer Contracting, Inc., 11000 93 <sup>rd</sup> Ave N Maple Grove MN 55369 Email: <a href="mailto:estimating@meyer-ci.com">estimating@meyer-ci.com</a> Website: meyer-ci.com	Verlyn Schoep Oneida Vendor MBE certified	Main:763-391-5959 Fax: 763-391-5960
--	---	--

Mission Support Services 1033 N. Mayfair Road, Suite 202 Milwaukee, WI. 53226 E-Mail: <a href="mailto:MKunstman@oesllc.com">MKunstman@oesllc.com</a> Web Site: <a href="http://www.ms2llc.com">www.ms2llc.com</a>	Matt Kunstman Vendor #144118 Oneida Vendor SBA Certified	(920) 360-6710 cell (920) 884-3970 (414) 257-2492fax
---	---	--



White Buffalo Trucking LLC. W1357 Tall Feather Way Seymour, WI. 54115 E-Mail: <a href="mailto:ahacker1@new.rr.com">ahacker1@new.rr.com</a>	Amy & Cale Hacker Vendor # 147141 Oneida Vendor DBE Certified	(920) 737-4520 (920) 737-4520 cell
---	--	---------------------------------------

## **DRYWALL & INSULATION**

Align Remodeling & Construction LLC 3701 N. Casaloma Drive Appleton, WI. 54913 E-Mail: <a href="mailto:nick@alignremodelingllc.com">nick@alignremodelingllc.com</a> Web Site: <a href="http://www.alignremodelingllc.com">www.alignremodelingllc.com</a>	Kimberly Smith Vendor #	(920) 475-3685
---	----------------------------	----------------

Denkins Drywall, Inc. W2024 Industrial Drive Kaukauna WI 54130 E-Mail: <a href="mailto:info@denkinsdrywallinc.com">info@denkinsdrywallinc.com</a> Web site: <a href="http://www.denkinsdrywallinc.com">www.denkinsdrywallinc.com</a>	Jeff Denkins Vendor # Sault Ste Marie Tribe	(920) 788-5552 (920) 7884080 fax (920) 851-1475cell
--	---	---

Tee Construction LLC 4150 Merrimac Way Oneida, WI 54155 E-Mail: <a href="mailto:Anthonyfranco@Gmail.com">Anthonyfranco@Gmail.com</a>	Anthony Franco Oneida Vendor  NAICS CODE 236115, 1521	(920) 865-5468
---	--	----------------

## **EXCAVATION**

Meltz Industries LLC N7565 Bodart Court Vendor # #144945 Seymour. WI54165 Oneida Vendor E-Mail: <a href="mailto:Cmeltz@meltzindustries.com">Cmeltz@meltzindustries.com</a> Website: <a href="http://www.meltzindustries.com">www.meltzindustries.com</a>	Crystal Meltz  WBE Certified MDE Certified	(920)609-1548 (920)-850-3994
--	---	---------------------------------

White Buffalo Trucking LLC. W1357 Tall Feather Way Seymour, WI. 54115 E-Mail: <a href="mailto:ahacker1@new.rr.com">ahacker1@new.rr.com</a>	Amy & Cale Hacker Vendor # 147141 Oneida Vendor DBE Certified	(920) 737-4520 (920) 737-4520 cell
---	--	---------------------------------------

## **FIRE ALARM/LIFE SAFETY, ACCESS CONTROL & SECURITY SYSTEMS**

O-Tech Soluitons, LLC Wintercress Drive Green Bay WI 54313 E: Mail: <a href="mailto:cd@o-techsolucitons.com">cd@o-techsolucitons.com</a> Website/URL: <a href="https://o-techsolutions.com/">https://o-techsolutions.com/</a>	Curtis Danforth    8(a) MBE Certification	(920)265-2611 2075
---	---	--------------------

## **FLOORING**

Mavid Construction Services, LLC. 1609 Western Avenue, Suite A Green Bay, WI. 54303 Email: <a href="mailto:Zoar@mavidconstruction.com">Zoar@mavidconstruction.com</a>	Zoar Fulwilder   Vendor # 137381	(920) 965-0271 (o) (888) 494-0504 fax (920) 655-6023 cell
--	---	---

## **FOOD SERVICE**

WT Creations/Sister Bread W280 Reformatory Rd Oneida, WI. 54155 E-Mail: <a href="mailto:wthatsme@yahoo.com">wthatsme@yahoo.com</a>	Winnifred L.  Vendor #135747 Oneida Nation	(920) 869.1150 (920) 883-1124 cell
---	---	---------------------------------------

## **GAMING EQUIPMENT/UNIFORMS**

Gitchi Games, Inc. P.O. Box 335 Prescott, WI 54021 E-Mail: <a href="mailto:gjohn@gitchigaming.com">gjohn@gitchigaming.com</a> Website: <a href="http://www.gitchigaming.com">www.gitchigaming.com</a>	Gregory B. Johns Vendor #105692 Oneida Nation MBE Certified	(715) 262-8899 (715) 262-3447 fax
---	--	--------------------------------------

## **GENERAL CONTRACTOR**

Meyer Contracting, Inc., 11000 93 <sup>rd</sup> Ave N Maple Grove MN 55369 Email: <a href="mailto:estimating@meyerci.com">estimating@meyerci.com</a> Website: <a href="http://meyerci.com">meyerci.com</a>	Verlyn Schoep  Oneida Vendor MBE certified	Main:763-391-5959 Fax: 763-391-5960
--	---	--

Mission Support Services 1033 N. Mayfair Road, Suite 202 Milwaukee, WI. 53226 E-Mail: <a href="mailto:MKunstman@oesllc.com">MKunstman@oesllc.com</a> Web Site: <a href="http://www.ms2llc.com">www.ms2llc.com</a>	Matt Kunstman Vendor #134114 Oneida Owned SBA Certified	(920) 360-6710 cell (920) 884-3970 (414) 257-2492fax
---	--	--

## **HVAC SALES WHOLESALE EQUIPMENT**

Omega Fields Inc. dba, Cool Running Air Conditioners & More 3708 Playbird Rd. Sheboygan WI. 53083 E-Mail: <a href="mailto:Sean@Omegafields.com">Sean@Omegafields.com</a> Website: <a href="http://www.coolrunnlnghs.com">www.coolrunnlnghs.com</a>	Sean Moriarty  Vendor # <u>Oneida Vendor</u>	Main 920-797-4602 Fax 920-476-1000 Cell 920-889-9273
---	---	--

Diamond HVAC LLC 922 Lambeau St Green Bay, WI 54303 E-Mail: <a href="mailto:Diamondhvacllc@gmail.com">Diamondhvacllc@gmail.com</a> Website: <a href="https://.diamondhvacgb.com">https://.diamondhvacgb.com</a>	Fawne Rasmussen Vendor #145210 Tribe; Oneida Tribe	920-764-2482
---	--	--------------

## **HOME RENOVATION & REPAIR**

Align Remodeling & Construction LLC 3701 N. Casaloma Drive Appleton, WI. 54913  E-Mail: <a href="mailto:nick@alignremodelingllc.com">nick@alignremodelingllc.com</a> Web Site: <a href="http://www.alignremodelingllc.com">www.alignremodelingllc.com</a>	Kimberly Smith Vendor #	(920) 475-3685
---	----------------------------	----------------

Tee Construction LLC 4150 Merrimac Way Oneida, WI 54155 E-Mail: <a href="mailto:Anthonyfranco@Gmail.com">Anthonyfranco@Gmail.com</a>	Anthony Franco Oneida Vendor  NAICS CODE 236115, 1521	(920) 865-5468
---	--	----------------

## **INTER-TRIBAL DEPARTMENTS & ENTERPRISES**

Anna John Resident Centered Care 2901 S. Overland Road Oneida, WI 54155 E-Mail:	Vendor #100762 Oneida Vendor	(920) 869-2797 (920) 869-3238 fax
--	---------------------------------	--------------------------------------

Bay Bank Packerland Drive Green Bay, WI 54313 Website: <a href="http://www.baybankgb.com">www.baybankgb.com</a>	Jeff Bowman Vendor #112294 Oneida Vendor	(920) 490-7600 (920) 490-0930 fax
--	--	--------------------------------------

Department of Public Works (Plumbing) W1278 Ranch Road Oneida, WI. 54155 E-Mail	Vendor #105007 Oneida Vendor	(920) 869-1059 (930) 869-1559 fax (920) 713-8644 cell
--	---------------------------------	---

Mission Support Services 1033 N. Mayfair Road, Suite 202 Milwaukee, WI. 53226 E-Mail: <a href="mailto:MKunstman@oesllc.com">MKunstman@oesllc.com</a> Web Site: <a href="http://www.ms2llc.com">www.ms2llc.com</a>	Vendor #134114 Oneida Vendor SBA Certified	(920) 360-6710 cell (920) 884-3970 (414) 257-2492 fax
---	--	---

Oneida Community Cannery (Tsi?Kute K) N7210 Seminary Road Oneida, WI 54155 E-Mail: <a href="mailto:cannery@oneidanation.org">cannery@oneidanation.org</a>	Vendor # Oneida Vendor	(920) 869-4579 (920) 869-1059 fax  (920) 869-4379
--	---------------------------	--

Oneida Nation Agricultural Center N6010 County Road C Seymour, WI. 54155 E-Mail: <a href="mailto:farm@oneidanation.org">farm@oneidanation.org</a> Oneida Nation Agri Center (Farm & Orchard)	(Farm & Orchard) Vendor #100078 Oneida Vendor	(920) 833-7952 (920) 833-2559 fax  (920) 833-7952
--	---	--

Oneida Nation Wardrobe Department 2170 Airport Rd Green Bay, WI 54313	Vendor # Oneida Vendor	(920) 494.4500 (920)429.3444
---	---------------------------	---------------------------------

Oneida Printing Enterprises		(920) 496-5624
-----------------------------	--	----------------

PO Box 365  
Green Bay, WI 54303  
E-Mail: MDANFOR8@oneidanation.org

Vendor #100807  
Oneida Vendor  
MBE Certified

Oneida Total Integrated Enterprise  
2555 Packerland Drive  
Green Bay, WI. 54313  
E-Mail: [mkunstman@otie.com](mailto:mkunstman@otie.com)  
Website: [www.otiesolutions.com](http://www.otiesolutions.com)

Vendor #134114  
Oneida Nation Owned  
SBA Certified  
(920) 360-6710 cell  
(920) 884-3970  
(920) 884-3989 fax

Radisson Hotel & Conference Center  
2040 Airport Drive  
Green Bay, WI. 54311  
Website: [www.radisson.com/greenbaywi](http://www.radisson.com/greenbaywi)

Oneida Airport Hotel  
Vendor #100047  
Oneida Nation Owned  
(920) 494-7300  
(920) 494-9599 fax

Wingate by Wyndham Green Bay  
2065 Airport Drive  
Green Bay, WI. 54311  
Website: [www.wingatehotels.com/greenbaywi](http://www.wingatehotels.com/greenbaywi)

Oneida Airport Hotel Corp.  
Vendor #122788  
Oneida Nation Owned  
(920) 617-2000  
(920) 617-2001 fax

## **LANDSCAPING**

Meltz Industries LLC  
N7565 Bodart Ct  
Seymour, WI 54165  
E-Mail: [Cmeltz@meltzindustries.com](mailto:Cmeltz@meltzindustries.com)  
MDE Certified

Crystal & Charles Meltz  
Vendor # 144945  
Tribe; Oneida Nation  
WBE Certified Website: [www.meltzindustries.com](http://www.meltzindustries.com)  
(920) 609-1548

## **OFFICE SUPPLIES**

True North Resources  
4906 S. Woodlawn PL  
Milwaukee, WI 53228  
E-Mail: [kathrynt@truenorth-resources.com](mailto:kathrynt@truenorth-resources.com)  
Website:

Kathry F. Tureske  
Vendor # #  
Oneida Vendor  
(414) 460-4909  
(414)-529-1013

## **PAINTING**

Align Remodeling & Construction LLC  
3701 N. Casaloma Drive  
Appleton, WI. 54913

E-Mail: [nick@alignremodelingllc.com](mailto:nick@alignremodelingllc.com)  
Site: [www.alignremodelingllc.com](http://www.alignremodelingllc.com)

Kimberly Smith  
Vendor #

(920) 475-3685

Go-Green Painting, LLC

1440 Acorn Drive  
Green Bay, WI 54304

E-mail Address: [gogreenpainting@new.rr.com](mailto:gogreenpainting@new.rr.com)  
Website: [www.go-greenpainting.com](http://www.go-greenpainting.com)

Allen Danforth  
Vendor # 139589  
Tribe; Oneida Nation

(920) 366-0778  
Office & Cell

## **PHOTOGRAPHER**

D. King of Images, LLC

N6944 Cornelius Circle

Oneida, WI. 54155  
E-Mail: [dking5293@me.com](mailto:dking5293@me.com)

Website: [www.dkingofimages.com](http://www.dkingofimages.com)

Dennis D. King  
Vendor #133675  
Tribe, Oneida Nation

(920) 606-5464 cell

## **PLUMBING**

Department of Public Works (Plumbing)

W1278 Ranch Road  
Oneida, WI. 54155

Vendor #105007  
Oneida Vendor

(920) 869-1059  
(930) 869-1559 fax  
(920) 713-8644 cell

Meltz Industries LLC

N7565 Bodart Court  
Seymour, WI 54165

E-Mail: [cmeltz@meltzindustries.com](mailto:cmeltz@meltzindustries.com)  
Website: [www.meltzindustries.com](http://www.meltzindustries.com)

Crystal Meltz  
Vendor # #144945  
Oneida Vendor  
WBE Certified  
MDE Certified

(920) 609-1548  
(920)-850-3994

## **PRINT SHOP**

Oneida Printing Enterprises  
PO Box 365

Vendor #100807

(920) 496-5624

Green Bay, WI 54303  
E-Mail: MDANFOR8@oneidanation.org

Oneida Vendor

## **SAFETY CONSULTING**

Mission Support Services	Matt Kunstman	(920) 360-6710 cell
1033 N. Mayfair Road, Suite 202	Vendor #134114	(920) 884-3970
Milwaukee, WI. 53226	Oneida Owned	(414) 257-2492fax
E-Mail: <a href="mailto:MKunstman@oesllc.com">MKunstman@oesllc.com</a> Web	SBA Certified	
Site: <a href="http://www.ms2llc.com">www.ms2llc.com</a>		

## **SITE PREPERATION**

Meltz Industries LLC	Crystal & Charles Meltz	(920) 609-1548
N7565 Bodart Ct	Vendor # 144945	
Seymour, WI 54165	Tribe: Oneida Nation	
E-Mail: <a href="mailto:Cmeltz@meltzindustries.com">Cmeltz@meltzindustries.com</a>	WBE Certified Website: <a href="http://www.meltzindustries.com">www.meltzindustries.com</a>	
MDE Certified		

## **SNOWPLOWING, RESIDENTIAL/COMMERCIAL**

Josh Bailey Concrete LLC	Josh Bailey	(920) 569-9708 cell
1949 Candle Way	Vendor # 147125	
Green Bay, WI 54304	Tribe: Oneida Nation E-	
Mail: <a href="mailto:jbconstr123@gmail.com">jbconstr123@gmail.com</a>		
Web Site: <a href="http://JoshBaileyConcrete.com">Josh Bailey Concrete.com</a>		

White Buffalo Trucking LLC.	Amy & Cale Hacker	(920) 737-4520
W1357 Tall Feather Way	Vendor # 147141	(920) 737-4520 cell
Seymour, WI. 54115	Tribe: Oneida Nation	
E-Mail: <a href="mailto:ahacker1@new.rr.com">ahacker1@new.rr.com</a>	DBE Certified	

## **SOLID WASTE LANDFILL**

Vandekamp Services, LLC	Jessica & Cory Vandekamp	(920) 241-5763
N6429B County Rd E	Vendor # 146916	
DePere, WI 54115	Tribe; Oneida Nation	
E-Mail Address: <a href="mailto:jesswallenfang@gmail.com">jesswallenfang@gmail.com</a>		

## **STRUCTURED CABLING, CCTV**

O-Tech Solutions, LLC Wintercress Drive Green Bay WI 54313 E: Mail: <a href="mailto:cd@o-techsolucitons.com">cd@o-techsolucitons.com</a> Website/URL: <a href="https://o-techsolutions.com/">https://o-techsolutions.com/</a>	Curtis Danforth    8(a) MBE Certification	(920)265-2611 2075
---	---	--------------------

## **TRUCKING**

White Buffalo Trucking LLC. W1357 Tall Feather Way Seymour, WI. 54115 E-Mail: <a href="mailto:ahacker1@new.rr.com">ahacker1@new.rr.com</a>	Amy & Cale Hacker Vendor # 147141 Tribe; Oneida Nation DBE Certified	(920) 737-4520 (920) 737-4520 cell
---	---	---------------------------------------

## **TELECOMMUNICATIONS, ELECTRICAL & SPECIAL SYSTEMS**

O-Tech Solutions, LLC Wintercress Drive Green Bay WI 54313 E: Mail: <a href="mailto:cd@o-techsolucitons.com">cd@o-techsolucitons.com</a> Website/URL: <a href="https://o-techsolutions.com/">https://o-techsolutions.com/</a>	Curtis Danforth    8(a) MBE Certification	(920)265-2611 2075
---	---	--------------------

## **VOICE & DATA COMMUNICATIONS SYSTEMS**

## **WATER & SEWER LINE CONSTRUCTION**

Meltz Industries LLC N7565 Bodart Ct Seymour, WI 54165 E-Mail: <a href="mailto:cmeltz@meltzindustries.com">cmeltz@meltzindustries.com</a>	Crystal & Charles Meltz Vendor # 144945 Tribe: Oneida Nation WBE Certified Website: <a href="http://www.meltzindustries.com">www.meltzindustries.com</a>	(920) 609-1548
O-Tech Solutions, LLC Wintercress Drive Green Bay WI 54313 E: Mail: <a href="mailto:cd@o-techsolucitons.com">cd@o-techsolucitons.com</a> Website/URL: <a href="https://o-techsolutions.com/">https://o-techsolutions.com/</a> MDE Certified	Curtis Danforth    8(a) MBE Certification	(920)265-2611 2075



## **WINDOW SERVICE**

Championship Window Cleaning LLC  
2130 W. Tripoli Ave  
Milwaukee, WI 53221  
[championshipwindowcleaning@outlook.com](mailto:championshipwindowcleaning@outlook.com)

Meeyoqitut Joseph Spencer (608)628-4111  
Vendor #  
Tribe; Oneida Nation E-Mail:

# Attachment E

## Document 00 31 43 – PERMIT FEE SCHEDULE

### 3. GENERAL

#### 3.1. PERMITS

- A. Permits are required for this project. All required building and other permits shall be obtained by the Contractor before beginning construction.
- B. All applicable building and other permits shall be obtained by the Contractor from the following.
  - 1. Permits for Work within the property boundaries shall be obtained from the Oneida Zoning Department.
  - 2. Permits for Work outside of the property boundaries shall be obtained from the municipality having jurisdiction.
- C. For questions regarding the Oneida Zoning Department Permit Fee Schedule, please contact:

Troy Parr – Zoning Administrator  
N7332 Water Circle Place  
Oneida, WI 54155  
PH: 920-869-4529  
FAX: 920-869-1610  
[tparr@oneidanation.org](mailto:tparr@oneidanation.org)

END OF 00 31 43 – PERMIT FEE SCHEDULE

ONEIDA ZONING DEPARTMENT – PERMIT FEE SCHEDULE FOLLOWS



## ONEIDA ZONING DEPARTMENT PERMIT FEE SCHEDULE

*Adopted By Oneida Business Committee Resolution – March 13, 2013*

### **Residential / UDC / R1, R2**

SPS 320 - 325

General Construction *	\$ 25.00	
Electrical	\$ 25.00	
Plumbing	\$ 25.00	
HVAC	\$ 25.00	
Fire Suppression System	\$ 25.00	
Land Use	\$ 25.00	(Oneida Law 69.10-1)

Permits Not Required for Replacement of non-structural items (following are examples), A permit taken out for work under this section has no fees attached.

Windows	Flooring
Soffit / Fascia	Driveway
Siding	Toilets / Sinks
Re shingling roof	Concrete Patios
Water Heater	

### **Emergency Furnace Replacement**

Furnace is installed  
Contractor reports installation to Oneida Zoning  
Contractor submits affidavit to Oneida Zoning (Emergency Furnace Affidavit)  
\$25.00 payment (HVAC FEE)

### **PUD (Oneida Law 69.9)**

Filing Fee	\$500.00
Deposit	**

### **Razing Permit (Oneida Law 66.20)**

R-1	\$25.00
Agriculture	\$75.00
Commercial	\$200.00

\* Includes Pools, Fences, Accessory Buildings

\*\* As determined by the Zoning Administrator on a project by project basis